

# Techniques For Reducing Energy And Delay For Data Aggregation In Wireless Sensor Networks

Muhammad Shoaib Akhtar, Tao Feng\*

School of Computer and Communication, Lanzhou University of Technology, Lanzhou 730050, China

## Abstract

WSN have many applications in different fields like medical, military, health and agriculture, etc., due to its data sensing and gathering abilities to Base station. The main issue in wireless sensor network is energy efficiency under consideration of QOS parameter like delay and security. Many of techniques have been proposed in literature but few work on energy efficient network with QOS. Due to lack of prior research in this area of study, this research will optimize the existing result in manner of giving efficient energy mechanisms and will also provide QOS as well as reduction of delay. It is very important to calculate energy efficiency and data transmission rate in wireless sensor networks because it is widely used in every field of life, especially when we are talking about medical, military and navigation system. After identifying main issues, this research will focus on energy efficiency and delay reduction. But other factors like security and average transmission time is not fully focused.

**Keywords:** WSN, QOS, Data Aggregation

Received on 25 June 2022, accepted on 02 August 2022, published on 11 October 2022

Copyright © 2022 Muhammad Shoaib Akhtar *et al.*, licensed to EAI. This is an open access article distributed under the terms of the [CC BY-NC-SA 4.0](#), which permits copying, redistributing, remixing, transformation, and building upon the material in any medium so long as the original work is properly cited.

doi: 10.41010.4108/eectct.v9i3.2140

\* Corresponding author. Email: [13.cs.194@gmail.com](mailto:13.cs.194@gmail.com)

## 1. Introduction

Latest advancements in network world, self-configured and having less infrastructure network architecture always be on top priority [1]. Wireless sensor networks having these features and consist multifarious sensor nodes which are distributed and particular base stations [2]. These sensor nodes have ability to measured environment circumstances like pollution levels, temperature, humidity, etc. nodes are deployed in monitoring areas in distributed manner [3].

In last few years, most of research has been done in wireless sensor domain and still standing as hot topic in research areas like energy consumption, delay, security, data aggregation and QOS in wireless sensor network. But there are still many challenges in this domain. Sensor nodes are having low consumption capacity and not energy efficient with several security threats. Data aggregation is a complex scenario in WSNs [4]. Unlike other networks, WSNs protocols mechanism complications are increasing due to impossibility of human activities because of uncertain

deployment area of sensor node. Enormous researches has been done on QOS but the important thing that these QOS aren't guaranteed [5].

Due to outage the consumption of the energy in sensor nodes, there is the big issue to maintain QOS in WSN. Only limited work has been done to maintain both QOS and security with data aggregation. (Kim, Yun and Kim, 2020) has tried to overcome on the issue of QOS and security at same time, but it does not take average transmission time into account. There is another issue in link and data aggregation to maintain QOS for efficient energy. Singh et al [6] proposed fuzzy logic technique in which data aggregation of different domain automatically reported by sensors. But still there is need to propose improved model which maintains security as well as efficient energy in term of quality of service with minimum delay transmission. That's why my main focus is to present a novel improved model in which reliable efficiency to enhance the life of wireless sensor nodes and their consumption by using LEACH and some others protocol.

In wireless sensor network the main problem is trade-off between energy and delay required in WSN. To provide a

solution for this need to propose energy efficient and delay reduction optimistic model for future data aggregation.

Current advancement in wireless sensor network is about energy efficiency long life network including QOS. Sensor nodes are used to deploy in many fields like in battlefield, health environment for collecting of data. For this increasing in demand in every field, some main challenges have been seen like security, energy efficiency and localization of nodes.

- 1) The goal of this research is to study how Author can enhance lifetime of network and how Author will reduce the delay.
- 2) An algorithm will be proposed to achieve best security of nodes with data aggregation.
- 3) Improved scheme will be proposed in this Research.

## 2. Literature Review

To eliminate data redundancy, data aggregating is the one of the top most techniques for this purpose. Authors present ESPDA protocol to provide secure energy-efficient data aggregation. NOVSF technique which is block-hopping improves the security whenever map is changed in WSNs. In data aggregation; Energy consumption dissipation and randomly deployment are major draw backs in wireless sensor networks. Authors proposed EDAGD technique with three algorithms MTDA, ETA and GDA which overcome this drawback[6]–[8].

Data aggregation needs to estimate link cost authors design a ZigBee WSNs to improve route selection in multi-hop environment. U-RR procedure is implemented in this paper and simulation results are showing that cost of link is reduced and allowed different nodes to select better route for achievement of require QOS.V3[9], [10].

With data aggregation, there is need to enhanced energy efficiency with lifespan of sensor nodes; LEACH technique proposed by authors to overcome the limitation in energy resources. In this paper, authors proposed LEACH with generic algorithm which is optimized. Simulated MATLAB results showing 17.39% energy consumption rate has been reduced. Another research proves that LEACH provides good Quality of services in energy consumption. In LEACH routing protocol it select best cluster-heads with the maximum current energy and very small distance with base sink node. The simulation is performed on MATLAB which shows better result than other conventional protocol [11]–[13].

Sensor nodes are mostly deployed in remote area so the clustering technique of nodes is the key for energy efficient and increase life of the network[14], [15] proposed energy efficient heterogeneous clustering technique which increases the life of wireless sensor network. Another work has been done by [16]–[18] on unequal clustering algorithm based on interval type2 TSK fuzzy logic in which residual energy, RDB and ND is taken as input. Output is taken with fuzzy logic to optimize CH and cluster size. The result shows that UCT2TSK improves energy efficiency than other traditional clustering algorithm [19], [20]. To overcome on energy

issues, another work has been done with in manner of effective energy there is one more technique is Fuzzy-logic which based on data aggregation. Authors proposed techniques to collect classifies and aggregate the data family of different areas, Fuzzy-logic is applied to enhance energy efficiency and improves QOS. Proposed techniques also evaluate and comparing with existing technique EESS with Fuzzy-logic. Result shows Fuzzy-logic is more valuable techniques and enhance energy efficiency [21]–[24].

Shafique et al [25] proposed effective data aggregation tree for communication and routing which is based on cluster model by changing inter cluster energy consumption method using fuzzy logic chose the node density, capacity and head for load as well as To minimize the energy consumption Author used data correlation model and data compression model. Author proposed model result show that it increases the life of network, performance and decrease the energy consumption.

K et al [26] proposed Entropy-driven Data Aggregation with Gradient Distribution (EDAGD) technique to maximize lifetime of WSN and reduce energy consumption with three strategy which are multi-hop tree-based Data Aggregation (MTDA) architecture to reduce the hop require in path during data transmission process. Another Based on the Choquet integral and entropy proposed Entropy-driven aggregation Tree-based routing Algorithm (ETA) used for save the energy during the transmission process by monitor the event of the abnormal sensor area with sensing but other are sleep mode. Gradient Deployment Algorithm (GDA) used to solve the problem in energy. The proposed result shows that it increases the Lifetime of WSN near 60% on average compare with random development method.

M et al [27] proposed hybrid optimization method to enhance the lifetime of WSN network using Proactive routing algorithm by the combination of soft computing techniques viz. genetic algorithm ( GA used to minimum the energy and communication distance while send the data to base station) and bacteria foraging optimization (BFO) techniques are used to achieve the shortest and secure path to enhance the lifetime of WSN and used destination sequence distance vector (DSDV) routing protocol and after that the hybridization of GA and BFO is applied on the same routing protocol. Author proposed method result shows that it is best for smaller size of WSN. [28], [29] proposed Energy Aware Decision Stump Linear Programming Boosting Node Classification based Data Aggregation (EADSLPBNCA) Model to reduce the energy consumption in WSB during data aggregation as well as this model used with linear programming boosting classification (LPBC) model to combine the weak decision stump to build the strong classifier of each input node as high and low energy by which reduced the misclassification error where increase the performance and lifetime of Wireless sensor network with low sensor node transfer data to high sensor nodes where distance is identify through Manhattan distance where at the end all data gather in high sensor node which increase the performance with accuracy and network lifetime of data aggregation with minimum delay.

Anawar et al [30] proposed synchronous and asynchronous method for reducing delay factor with

enhancing the duty cycle of nodes. In this work, Size of forwarding node-set (SFNS) also kept in consideration while transmitting data and information. With this proposed method author gets dramatically result in reduction of delay, but still need to improve energy efficient network. Another work has been done on delay reduction by [22], [24], [30] which also based on the duty cycle. In order to reduce delay author, set duty cycle to 1, with this result is effectively improved in sleep delay of nodes. But the limitation of this work was that this only focused for industrial wireless sensor network, furthermore work can be done on internet of things technologies. Lu et al [10] proposed an autoregressive integrated moving average (ARIMA) model to protect the data aggregated using Hadoop framework for Wireless sensor network to preserve the data privacy, Time series analysis method are used to protect the data by adversaries as well as Author scheme provide the prediction of data storage in sensor node, data updating. Author experimental result shows that Author proposed method show high accuracy, communication and computation cost as well as achieve the best result. But in limitation in this paper don't care about data integrity which Author further study in future. Peng et al [12] proposed data aggregation model in wireless sensor network (WSN) using firefly algorithm, where Author using cluster for active node and inactive node In active node Author identify the Area size, energy, as well as Author proposed method, proposed method protect the data from duplication and network is do not imposed on extra overhead. Author simulation result show that Author method is more efficient rather than previous method where Author enhance the QoS by using shuffled frog algorithm and low energy adaptive clustering hierarchy.

### 3. Methodology

This section outlines the methodological steps of Author work, in the first step Author shown the data aggregation mode and theoretical presentation of alternative models of Data Aggregation for QoS improvement. After that Author have utilized Whale optimization technique on the best model to evaluate the best outcomes.

#### 3.1. Overview

WSNs are composed of a large number of sensor nodes that are distributed over an area and are utilized for a certain purpose. WSNs cover a broad range of applications in a number of industries, including environmental monitoring, military applications, healthcare, industrial process management, and home intelligence, security, and monitoring. All of these nodes, which are typically small in size, may be processed, communicated, and sensed. Sensor nodes communicate through short-range radio waves and collaborate to perform shared tasks. Sensor nodes, on the other hand, have a finite amount of bandwidth, power, memory, computing resources, and endurance. A sensor node's primary function is to detect and communicate target

phenomena such as heat, light, and temperature to the host controller or sink through a query response. WSNs consume less energy for calculation than they do for data transport [3]. Rather of transmitting each piece of sensed data individually to the sink node, data can be collected and aggregated using aggregate methods such as sum (), average (), and so on..

#### 3.2. Data Aggregation

Data aggregation is the method by which useful information may be collected and aggregated in a particular area of interest in WSNs. The data aggregation technique is used to assess the efficiency of communication between nodes. Aggregation of data may be viewed as a fundamental processing activity aimed at conserving precious resources and reducing energy use.



Figure 1. Data Aggregation Process

The most critical limitations in sensor networks are the latency of the data aggregation and the longevity of the network. These two restrictions could not be optimized at the same time, as previously stated. Author aim is to preserve normal network life while minimizing latency of data aggregation. The strategy could be useful when time is essential. By creating a delay efficient network topology, Author could obtain the lowest achievable latency in Author method. Transmission distances of the sensor nodes are maintained to a minimum, which saves energy for the network.

In summary, this thesis makes the following contributions:

- Providing a technique for constructing a network structure with the shortest data aggregation delay.
- Comparing previous different algorithms of H-Leach Leach and some other previous techniques.
- Providing a distributed solution with the help of Whale Optimization Algorithm that scales effectively as the network grows larger.

#### 3.3. System Model

N wireless sensors are spread over the network and form a network. After deployment the placements of the sensor nodes and BS are not modified. It is considered that the energy consumption of sensors is linked to the square of their transmission distance. Author have used five aggregation models to calculate reduction and delay, after finding out the best algorithm, Author have applied WOA for more efficiency.

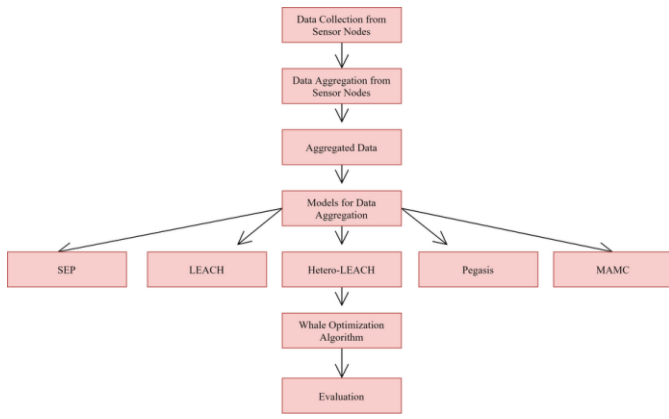

Figure 2. System Model

3.3.1. Theoretical Presentation of Data Aggregation

We assume that sensors' transmission ranges can be adjusted to directly reach additional nodes and the BS.

After travelling through aggregation channels, data from the sensor nodes is collected in the sink. Data fusion is planned to be perfect, which means that all data packets will be the same size. A slot is used to transfer data from a node to its parent. Due to the fact that each sensor has a single transmitter, simultaneous reception of multiple nodes is not permitted. Simultaneous transmission interference is reduced when CDMA-based sensors are used.

Cheng et al. propose an efficient data aggregation network topology that requires the least amount of time. The structure is a tree with a node count of two powers of two (2p). The CH serves as the cluster's root node, while the other cluster nodes are members (CM). The CH communicates with the BS directly via a data connection. A node's rank is determined by the number of data connections it has. Each of a rank k node's k-1 child nodes has its own range from 1 to k-1. The network depicted in Figure 2 is composed of three minimum delay aggregation trees with one, two, or four nodes, respectively.

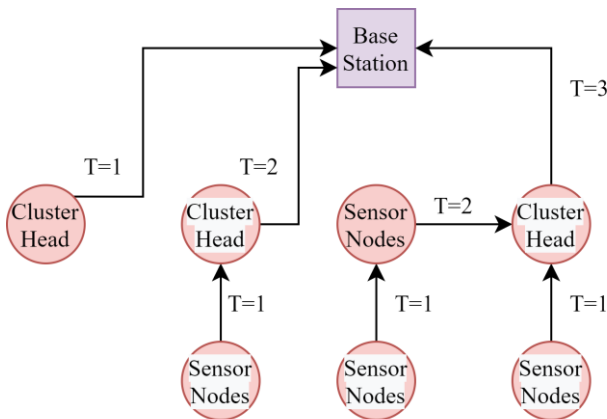

Figure 3. the network structure and scheduling with 7 nodes

Our approach to the aggregation problem is composed of two components: network construction and scheduling. During the network development phase, one or more data aggregation trees are constructed. Each tree is constructed using the least-delayed method described in the preceding section.

Sensor nodes are scheduled to transmit data during the planning phase, following the network structure's creation. Each node has a time window for aggregating and transferring data to its parent. Communication is expected during a single time period. A node can be received by only one packet per time slot.

During the construction phase, two identical clusters are combined to form a larger cluster in order to achieve the shortest possible delay structure. This operation is repeated until clusters can no longer connect directly to the BS or to other clusters of the same size. The final architecture of the network will be composed of clusters of varying sizes as a result of this method.

The scheduling algorithm is self-explanatory. Each node's time span is determined by its position in the network's topology. Each child node of a parent node has a unique rank, which corresponds to its transmission time. As a result, receiving multiple parent nodes is not possible. Due to the fact that each cluster is unique in size, the CHs are sorted differently. As a result, these CHs transmit data to the BS at different times.

Figure 2 illustrates Author network's structure and schedule. The schedule has been described, and the following section discusses the mechanics of the network construction process.

3.3.2. Hetero-LEACH

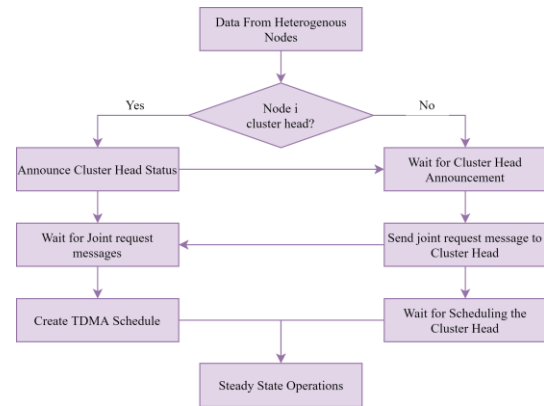

Figure 4. Hetero-Leach

To minimize interference, each cluster communicates using a direct spread spectrum sequence (DSSS). Each cluster communicates using a single sequence of spreading code. Clustering is said to be optimal when energy consumption is evenly distributed across all sensor nodes while consuming the least amount of energy possible. Assume there are N nodes in the M x M region. On average, each cluster will contain k clusters with a CH and (N/k)-1 non-CH nodes.



### 3.3.3. LEACH

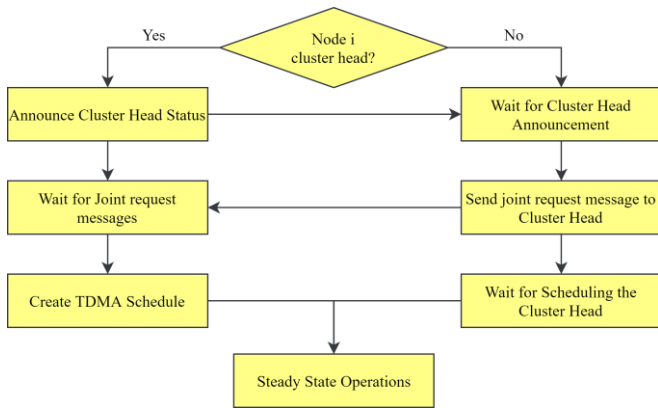

Figure 5. Gas LEACH

LEACH is the Low Energy Adaptive Clustering Hierarchy and the randomly selecting cluster heads is self-organizing clustering protocol for distributing energy load between the sensor nodes. The main features of LEACH are:

- Local co-ordination and monitoring of the data transmission,
- Randomized, self-configured and adaptive cluster formation

Low energy media access

### 3.3.4. MAMC

Num (Gift) should be set to 0. Begin with the R1 nodes. If you're creating a cluster head from R1, broadcast a Hello packet and the cluster head's ID (Give-up). Consider R2 nodes once R1 nodes are complete.

R1's cluster heads have become a benchmark. The distance between a node in R2 and a cluster head in R1 is taken into account, as is the random value of  $T(n)$ . Broadcast Hello and Number if all prerequisites are met (Give-up)

Alternatively, broadcast only the number (Give-up). If this message is received by nodes in other areas, it increases Num (Give-up) by 1 and subsequently modifies  $T(n)$  to improve a cluster heading probability.

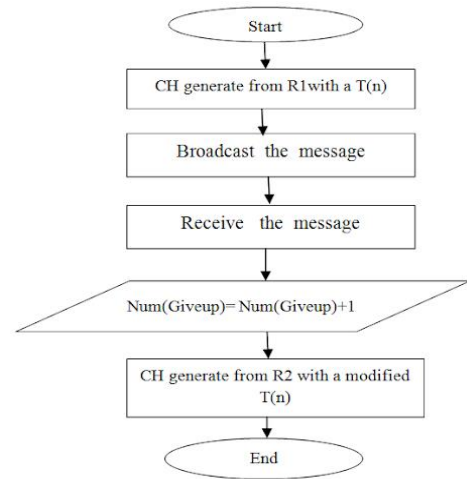

Figure 6. MAMC

### 3.3.5. Pegasus

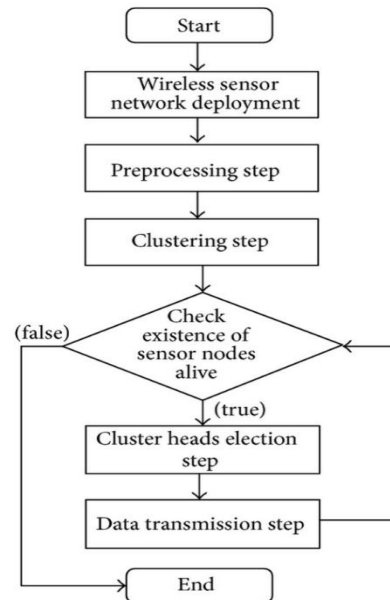

Figure 7. Pegasus

PEGASIS (EPEGASIS), part of the chain-based algorithms of routing. In EPEGASIS, each node uses an optimal communication distance to select the relay node for data transmission from its neighbors. In order to avoid excessive energy consumption at specific locations for certain nodes

### 3.3.6. Stable Election Protocol

SEP is a two level heterogeneous protocol that use two types of nodes, normal and advance. Advance nodes has more energy than normal nodes in order to create a backup for the energy and transmission, both the nodes have certain probability to become a cluster head.

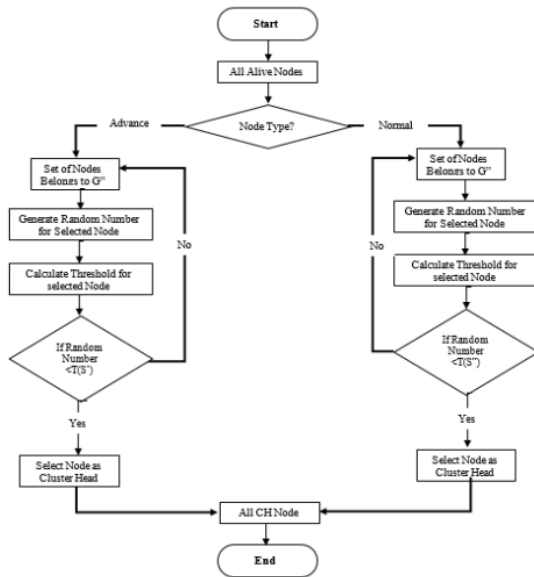

Figure 8. Stable Election Protocol

### 3.4. Data Aggregation using Multi-Objective Optimization Techniques

An optimization method can be utilized for the best and optimum solution or value. The issues of optimization consist of one or more objectives or of seeking minimal or maximum value. MOO is referred to as; issues with more than one purpose. Such problems may be seen in everyday life as in engineering, mathematics, economics, social studies, agriculture, cars, aviation and more. In different everyday problems, the goals are messing with each other. And maximizing a particular solution for a single goal might lead to unwanted outcomes for the other objectives. One logical and realistic answer to a multi-target problem is to analyze every option that meets the aims at an appropriate level without being overwhelmed or dominated by any extra solution. Therefore, according to Author study, two GA and NSGA-II algorithms are particularly created for situations with multiple targets. GA and NSGA-II are meta-heuristic, best suited for various sorts of issues mentioned in the next section. Traditional GA and NSGA-II are amended to offer multi-objective issues through methods to enable the variety of solutions and the application of specific fitness functions. Algorithm of Implementation of Data Aggregation with Whale Optimization:

**Start**  
**Input (Data Aggregation Model) i.e. (H-LEACH)**  
**Output (Optimized Cost Function, Optimized Fitness Value)**  
 Initialize the Whale Population  
 Set the location of Whale  
 $W = W_{new}$   
 If  
 The whale moves from a location to new at a new distance from new location

Then  
 $W = W_{new} + D$   
 Now  
 Create an Echo Coefficient  $C$  from Whale  $W$  at distance  $D$  to Search for a Prey or Agent  
 If  
 $C > 0.5$   
 Then  
 Search for Prey  
 If Echo reflects back in a certain direction  
 Then  
 $W = W_{new} (2\cosine(\pi r_l)) + W$   
 Then move whale to this direction  
 This path determines the prey  
 Make the fitness value  $(x,y)$   
 Optimize  $(x,y)$   
 End

#### 3.4.1. Whale Optimization Algorithm

The Whale Optimization Algorithm (WOA) was proposed in 2016 by Mirjalili and Lewis. This method has shown itself to solve a number of concerns. Natural algorithms such as ABC and PSO have also been explored extensively. However, no WOA survey was conducted.

WOA hybridization and adaptability are more important than WOA. Author research also provides the road for WOA and BAT algorithms to be integrated. The BAT algorithm is used for scanning and the WOA approach is used for use. Finally, in 16 benchmarking functions, WOA-BAT statistical result outperforms WOA [35].

Engineering, Internet browsing and management were attractive topics for optimization. Realistic apps can fight to cut time, increase quality and create money. The aim is to optimize the problem of limited resources while taking a variety of restrictions into account. Mathematical formulas and computer simulations are used for many successful search tactics to address optimization problems. Metaheuristic algorithms aim to balance location and unpredictability. These algorithms are therefore widely used worldwide [36].

Metaheuristic algorithms examine the search region with various alternatives to locate the best global solution, while local search is utilized to exploit the best recently identified solutions. This, together with the best options, guarantees spectacular solutions. Exploration also surmounts local optimism by producing random solutions [35].

Swarm-based metaheuristic algorithms address challenges of optimization by emulating animal behavior. Mirjalili and Lewis offered a technique to whale optimization in two ways. The first was to seek presence using a random or the best search engine, and the second was to recreate the strategy for bubble net hunting. Humpback whales enjoy chasing a little fish school. Thus they swim around the object in a small circle, forming a circle or '9' route imperfections [14].

Sensor nodes, sink nodes, gateway nodes and base stations are provided for UWSN. The sensor nodes send data to the sink nodes, which they receive and transfer to the gateway nodes to the base station to prepare the following step for technical staff. The optimal WSN energy

consumption and delay is the lowest energy consumption of the route under the data storage limit [37].

A new data storage whale optimization method (WOA) is presented using QoS limitations. The Whale Optimization Algorithm (WOA) is easy to compute. WOA does a first phase global search, but second phase local searches can produce a routing path that complies with QoS standards. WOA has stronger capacity for local search than other heuristic algorithms. Adverse: It's easy to reach the optimal local condition. The clone operator can succeed in preventing the development of optimal local conditions. The WOA has a faster rate of convergence, which makes it more viable. As a result, WOA is based on WOA but much more rapidly and optimally. WOA provides the ideal routing path with the least energy use, extends the life of UWSN's network and reduces plant costs. In addition, unlike normal WOA, clone and adaptive operators are available to WOA [35].

WOA uses adaptive circular predation, bubble net attacks, random hunts for prey, cloning and stop operations to discover the lead whale.

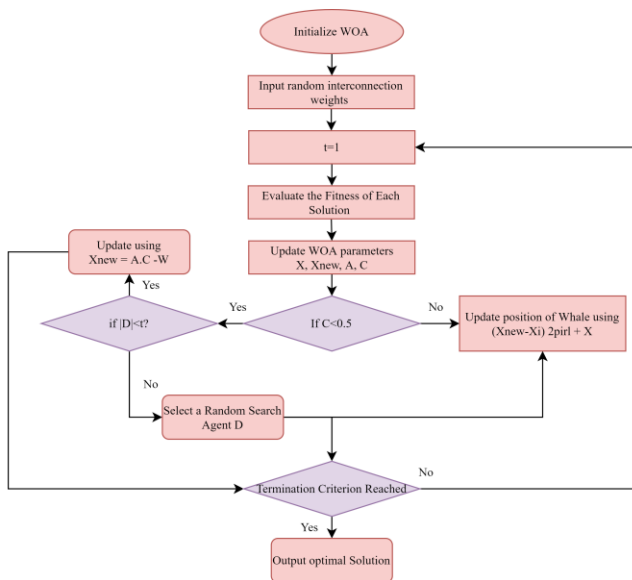

Figure 9. Whale Optimization Algorithm

### Initial Step

Encoding is the initial step in applying WOA to optimize the routing issue of UWSN's energy consumption. The specified objective is difficult to fulfil with standard decimal coding and the optimum routing is to use less energy under QoS restrictions. Binary encoding allows easy encoding and decoding. When binary encoding, 1 indicates that the node passes and 0 indicates that it does not pass. The first and last bits are both 1. As the source and destination nodes have to be passed. The 3rd and 4th bits are 1, shown by the first, 3rd, 4th and 5th nodes.

$$W = X.C - Xi \dots (4)$$

$$X_{new} = A.X - W \dots (5)$$

X is the whale location of W, while C, A are the coefficient random vectors

### Fitness and leading whale calculation

Fitness value reflects the energy consumption of a road in the costs limitation problem of routing energy consumption optimization. The fitness of each individual must be calculated in order to discover the position of the leading whale before any additional WOA activity.

### Net Bubble Attack

The whales' bubble-net assault behavior helps build a better solution for UWSN data storage costs. The bubble-net attack can be reproduced in two ways: one is the mechanism of the retrenched enclosure and the other the spiraling update.

The spiral improvement position means that whales swim in a spiral position on the surface and disperse bubbles of various sizes for shrimp and fish.

### Random Prey Search

In order to avoid optimum location in solving the problem of optimization routing under costs restrictions, the position of the whale cannot be changed only with the position of the leading whale and must occasionally be updated with the position of the partners.

Spiral Updating phase relates to exploitation phase which mimics the shape and movements of whales as follows:

$$X_{new} = |X_{new} - Xi| \cdot \cos(2\pi r l) + X \dots (6)$$

Where cos is the random location where whale tends to move for searching the prey. The WOA will in particular do a random search at this point and obtain the next position of the whale under the impact of the coefficient

The steps below can be expressed.

**Step 1.** Determines the number of sensors and population sizes, randomly constructs sensor nodes inside the monitoring region and randomly generates whale positions. Set the initial iteration and parameters.

**Step 2.** Compare, identify and define the lead whale by equation and compare them with their fitness.

**Step 3.** Enter the main algorithm loop if each whale updates its position, else it updates its position. If the whale updates its position.

**Step 4.** Update the coefficient of vectors and equations

**Step 5.** Calculate and classify the fitness of the whaling population by method 1, followed by high probability mutation for a cloned population.

**Step 6.** Calculate the fitness equation value for global value.

### 3.5. Link Weight Function

As discussed in the previous section, it is based on its weight that the link between two CCHs is decided. The connection weight should be commensurate with the distance between two end nodes, as Author objective is to reduce transmission distances for the sensor. When two clusters combine, the merging process will continue to participate only later in the nodes defined as CCHs of the

new composite cluster. All that remains is to specify their parents and complete their algorithms for the remaining nodes. As a result, the density of the CCHs decreases in successive rounds while the distances between the nodes rise. In order to remedy this problem, the link weight should be proportional to the distances between the two end nodes and the BS. Closer nodes are more likely to be selected as CCH clusters, and CCHs will eventually converge to BS. The distances between CCHs in future rounds will be reduced and the transmission distances will be shortened. The final CHs of the clusters are converged, which reduce the distance to the BS.

### 3.6. Performance Evaluation

The data aggregation performance parameters like network lifetime, energy efficiency, data accuracy, latency and data aggregation rate are described below:

#### Energy Efficiency

In an ideal world, each sensor would require the same amount of energy throughout each data collection round, but sensor nodes would need various amounts of energy for data transfer in practice. A data aggregation technology that is energy efficient in WSNs offers optimum functionality while using the lowest amount of power. The ratio of the amount of data transported successfully in a sensor network to the total energy consumed to transmit these data is energy efficiency. A building's energy efficiency is calculated by:

$$Energy\ Efficiency\ i = \sum_{i=1}^n \left( \frac{\text{Amount of data successfully transferred in a sensor network}}{\text{Total energy consumed to transfer those data}} \right) \dots (3.1)$$

Where n is the number of sensors nodes in a sensor network.

#### Network Lifetime

The network lifetime is the number of cycles completed by the data aggregation before the first sensor node runs out of energy. In other words, it's time to run out energy (battery power) or to disconnect the network from the first sensor node (or group of sensor nodes) on the network, due to one or more sensor failures:

$$NL_n^a = \min v \in V NL_v \dots (3.2)$$

Where the network lifetime ends as soon as the first node fails, with NL<sub>v</sub> being the lifetime of node v and V is the node set excluding the sink node.

#### Data Accuracy

The application for which the sensor network is created is specified in many circumstances. For instance, the close assessment of the target location on the sink specifies the data accuracy in the target location problem. Data correctness is defined as the data transfer ratio to the total data transferred:

$$Data\ Persistence = \left( \frac{\text{Amount of data transferred successfully}}{\text{Total amount of data sent}} \right) \dots (3.3)$$

#### Latency

The period between the data created at the source nodes and the received data packets on the sink is called latency. In other words, the time it takes for a sensor node to send data and receive data can be characterized by the latency. The following equation was used for latency calculation:

$$Latency\ i = \sum_{i=1}^L (\text{Time of receiving data} - \text{Time of sending data}) \dots (3.4)$$

Where n is the number of sensors nodes in a sensor network.

#### Data Aggregation Rate

The period between the data created at the source nodes and the received data packets on the sink is called latency. In other words, the time it takes for a sensor node to send data and receive data can be characterized by the latency. The following equation was used for latency calculation:

$$Data\ Aggregation\ Rate = (\text{Amount of data aggregated successfully} / \text{Total amount of data sensed}) \times 100 \dots (3.5)$$

## 4. Results

### 4.1. Data Aggregation Model Using Hetero-LEACH

To reduce interference, each cluster communicates using a direct spread spectrum sequence (DSSS). To communicate, all nodes in a cluster use the same spreading code sequence. When clustering, energy consumption is evenly distributed among all sensor nodes, resulting in minimal energy consumption. Assume there are M × M nodes in the area. On average, there will be k clusters, each containing one CH node and (N/k)-1 non-CH nodes.

A number of aggregate models will be used after the lowest feasible ideal energy is calculated, and then Whale optimization will be used for even greater reductions in delay and energy use. In the beginning, Author used the Hetero-Leach Algorithm. In table 1, each feature of H-LEACH has been presented and selected parameters can be seen as Dimensions are selected as x and y. While sink nodes are 0.5, 0.5 at x and y. Optimal Probability of Nodes is 0.2. There is 10 percent heterogeneity in the sensor nodes and maximum rounds in which the nodes can transfer the data is 7000.



Table 1. Selection of Parameters for h-LEACH

Dimensions	Sink (x,y)	Nodes	Optimal Probability of Node to Become Cluster Head	Energy Model (Initial Energy)	Heterogeneity Percentage	Maximum Rounds
Xm = 100 Ym = 100	Sink (0.5,0)	100	P=0.2	E = 0.5 Efs= 0.000 1 Eam p= 0.005	M = 0.1 A = 1	7000

Figure 10. Parameters for Setting up Hetero-Leach Test

Figure 11 shows the two types of nodes with different energy. Normal nodes are represented by 'o' and advanced nodes by '+' and base station by 'x.' the cluster formation in which cluster heads are represented by '\*' is shown in Figure below

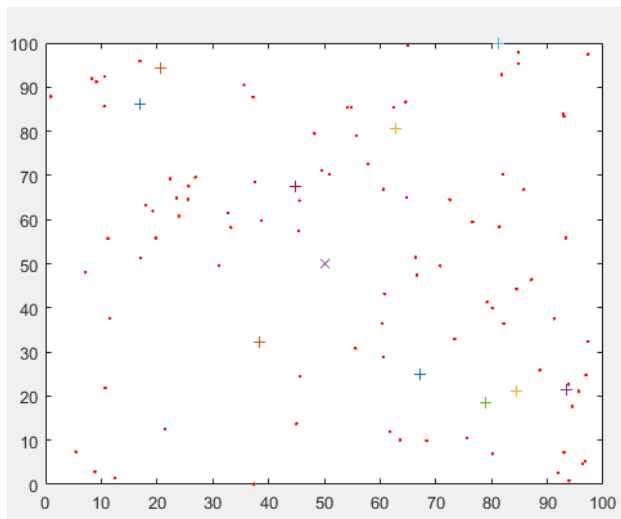

Figure 11. Heterogeneous LEACH protocol test network.

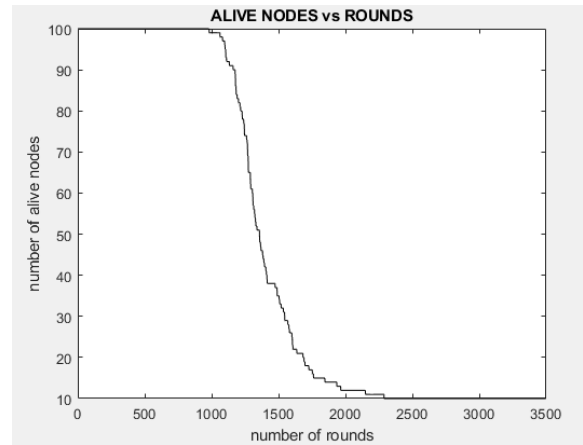

Figure 1. Performance of H-LEACH Algorithm

Figure 12 shows the number of alive nodes and dead nodes. It can be seen that at number 2300 of rounds, dead nodes are at maximum level. While at 1200<sup>th</sup> round, the stability period of wireless system declined.

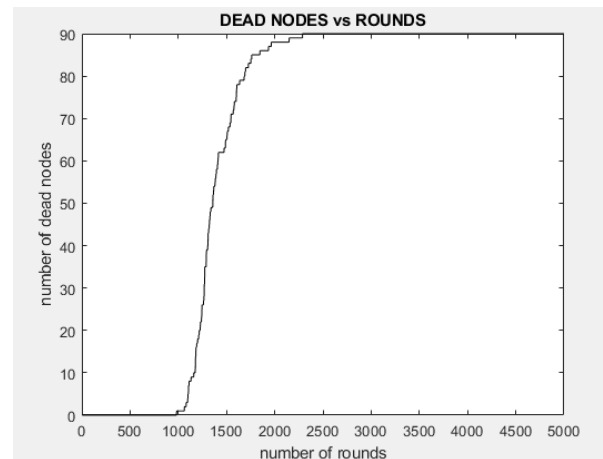

Figure 2. Performance of H-LEACH Algorithm for Number of Dead Nodes

Figure 13 shows the performance of H-LEACH in terms of dead nodes, maximum values of dead nodes can be seen at 2500<sup>th</sup> Round. While at 1200<sup>th</sup> round, the stability period of wireless system declined.

#### 4.2. Data Aggregation using LEACH

LEACH is the Low Energy Adaptive Clustering Hierarchy and the randomly selecting cluster heads is self-organizing clustering protocol for distributing energy load between the sensor nodes. The main features of LEACH can be seen in

Table 2:

- Local co-ordination and monitoring of the data transmission,
- Randomized, self-configured and adaptive cluster formation
- Low energy media access

Table 1. Selection of Parameters for LEACH

Dimensions	Sink (x,y)	Nodes	Optimal Probability of Node to Become Cluster Head	Energy Model (Initial Energy)	Heterogeneity Percentage	Maximum Rounds
Xm = 50 Ym = 50	Sink (0.5, 0.5)	50	P=0.25	E = 0.23 Efs= 0.0005 Eam p= 0.0023	M = 0.3 A = 2	7000

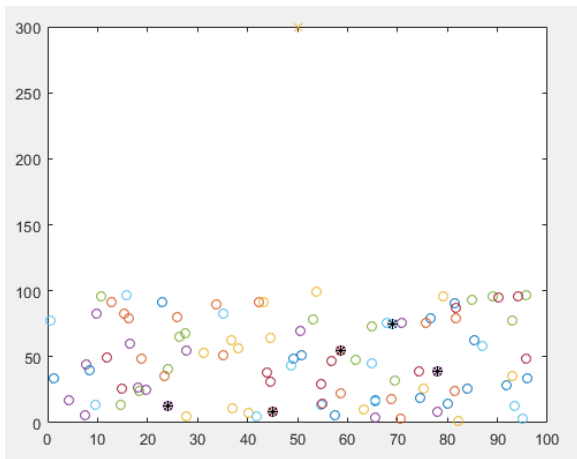

Figure 3. Data Aggregation using LEACH

Data aggregation using LEACH can be seen in Figure 14, as + sign indicates the sensor cluster head while o sign indicated the sensor nodes and x sign indicates the base station to which the data has been transferred by Cluster heads.

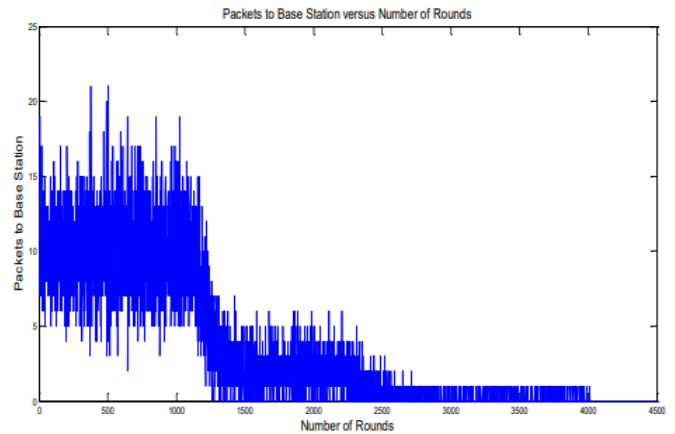

Figure 4. Performance of LEACH Algorithm for Number of Alive Nodes

Performance of LEACH can be seen in figure 15 in terms of number of nodes. At 4000<sup>th</sup> round all of the nodes has been dead and no data has been sent to bas station due to instability of the WSN which cause issues in QoS.

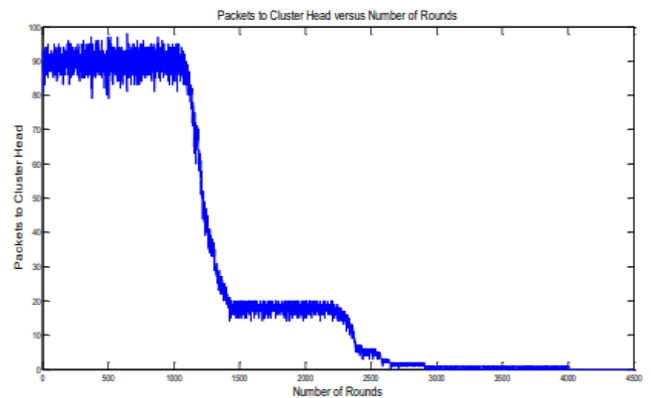

Figure 5. Performance of LEACH Algorithm for Number of Cluster Heads

Figure 16 shows the performance of LEACH algorithm in terms of alive nodes and selected cluster head. Packets send by cluster heads has a decline at 1200th round which means that the power of a cluster head is not sufficient to deliver more data packets to the base station.

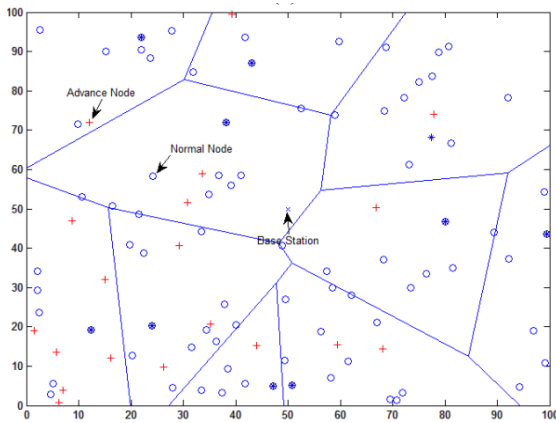

Figure 6. Calculating Link-Weight Functions

Figure 17 shows the link weight function of Base stations in LEACH. All the selected cluster heads created a function of link weights to share the power which will be available in future in order to not interrupt the transmission and connection between base station and cluster heads. Author goal is to lower sensor transmission distances, hence the weight of the connection should be proportional to the distance between the two end nodes. In the event that two clusters merge, the merging procedure will only participate subsequently in the nodes of the resulting composite cluster that are defined as CCHs. All that's left is to specify the nodes' parents and finish the algorithms on the rest of the network's nodes. As a result, the number of CCHs reduces as the distance between nodes increases in subsequent rounds. The link weight should be proportionate to the distance between the two end nodes and the BS in order to fix this issue. In CCH clusters, nodes that are closer to each other are more likely to be chosen, and clusters will eventually converge to BS if they aren't. The distances between CCHs will be lowered in subsequent rounds, as will the transmission distances. As the clusters' final CHs converge, the distance to the BS gets shorter.

### 4.3. Data Aggregation using MAMC

To deal with these developments and foster dynamic interoperability, a new strategy is required. Author strategy is to establish the concept of context as an explicit representation of WSN changes in metadata components, which then leads to judgments about how to maintain dynamic compatibility. Table 3 shows the list of parameters selected by MAMC algorithm for data aggregation.

Table 2. Selection of Parameters for MAMC

Dimensions	Sink (x,y)	Nodes	Optimal Probability of Node to Become Cluster Head	Energy Model (Initial Energy)	Heterogeneity Percentage	Maximum Rounds
Xm = 50 Ym = 50	Sink (0.5,0.5)	50	P=0.25	E = 0.23 Efs= 0.0005 Eamp = 0.0023	M = 0.3 A = 4	7000

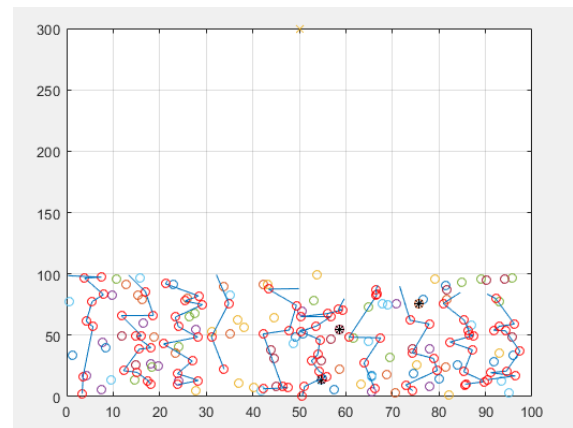

Figure 7. Data Aggregation and Link Weights using MAMC algorithm

Figure 18 shows the data aggregation of MAMC algorithm where the lines represent the link weight functions between cluster heads and base stations.

### 4.4. Data Aggregation using Pegasus

A routing technique based on chains called PEGASIS (EPEGASIS). Data transfer from neighbors is handled in PEGASIS by selecting the closest relay node using an optimal communication distance. We've set up a safety mechanism based on the average residual energy of nearby nodes to prevent excessive energy consumption at specified areas for certain nodes. Data is collected using a mobile sink to ensure that energy usage is balanced across regions. Parameters selected for Pegasus algorithms are shown in Table 4.

Table 3. Selection of Parameters for Pegasus

Dimensions	Sink (x,y)	Nodes	Optimal Probability of Node to Become Cluster Head	Energy Model (Initial Energy)	Heterogeneity Percentage	Maximum Rounds
Xm = 50 Ym = 50	Sink (0.5,0.5)	50	P=0.2	E = 0.23 Efs= 0.000 5 Eam p= 0.002 3	M = 0.3 A = 7	7000

Table 4. Selection of Parameters for SEP

Dimensions	Sink (x,y)	Nodes	Optimal Probability of Node to Become Cluster Head	Energy Model (Initial Energy)	Heterogeneity Percentage	Maximum Rounds
Xm = 50 Ym = 50	Sink (0.5,0.5)	50	P=0.2	E = 0.23 Efs= 0.000 5 Eam p= 0.002 3	M = 0.3 A = 7	7000

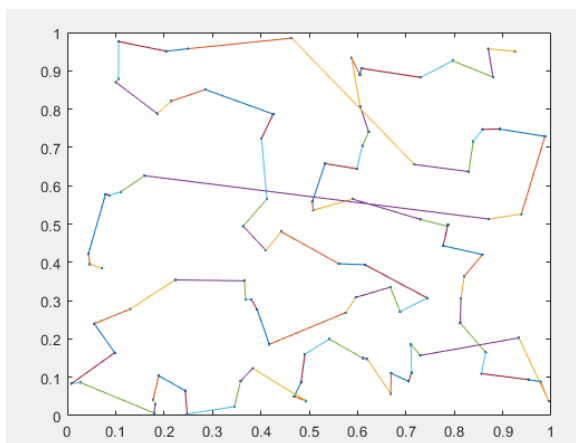

Figure 8. Data Aggregation and Link Weights using Pegasus algorithm

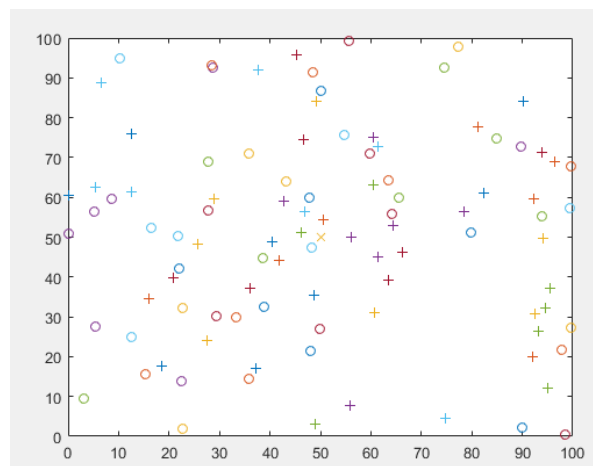

Figure 9. Performance of SEP Protocol

Link weight function in figure 19 has been shown. If the link weight function is created in an algorithm it means that there is no sufficient power or energy present in cluster head to deliver packets. So in Hetero LEACH there is no need of Link Weights because the stability period of the H\_LEACH algorithm is too much high.

### 4.5. Data Aggregation using Stable Election Protocol

Figure 20 shows the Stable Election Protocol test network. Two types of nodes with different energy are used. Normal nodes represent 'o' and '+' represent advanced nodes and 'x' represent the base station. The cluster formation in the cluster heads are shown in figure as '\*'

### 4.6. Energy Delay and Reduction Performance of Each Algorithm without Optimization

Table 5. Comparative Performance of Techniques

Techniques	Round for first Dead	Round for first 10 Dead	Round for first half alive Nodes	Round for all dead nodes	Stability Period	Energy Remaining at first 10 nodes
H-LEACH	2300	3230	4500	5400	1152	2300J
LEACH	456	1200	3243	1500	322	1000J
MAMC	1329	2500	3554	4000	900	600J
Pegasus	1200	1500	2100	2400	849	530J
SEP	2190	3100	4000	5000	1003	1300J



### 4.6.1. Whale Optimization Algorithm

Natural phenomena served as inspiration for the Whale Optimization Algorithm (WOA). This strategy has proven to be effective in dealing with a wide range of problems. Many studies have been done on other nature-inspired algorithms, such as ABC and PSO. Despite this, there has been no WOA survey to yet.

H-Leach will get WOA treatment to improve energy delay and reduction even further. Parametric space of WOA is being showed in Figure 21.

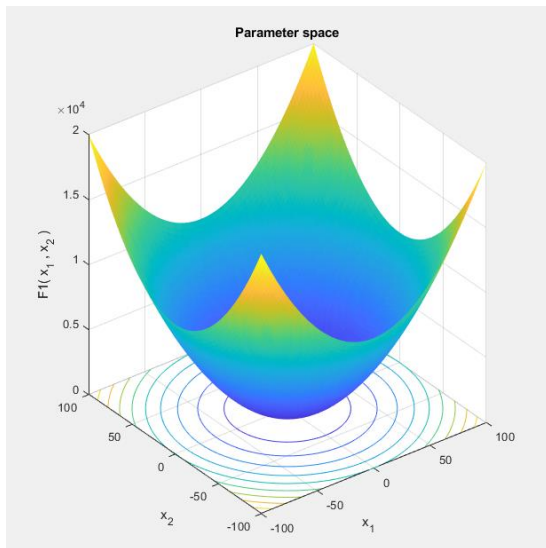

Figure 10. Parametric Space of Whale Optimization Algorithm

Table 6. Comparative Performance of Optimization and Without optimization of H-LEACH

Techniques	Round for first Dead	Round for first Dead	Round for first half alive Nodes	Round for all dead nodes	Stability Period	Energy Remaining at first 10 nodes
H-LEACH	2300	3230	4500	5400	1152	2300J
Optimized WOA	3000	4305	6000	6900	3000	4000J

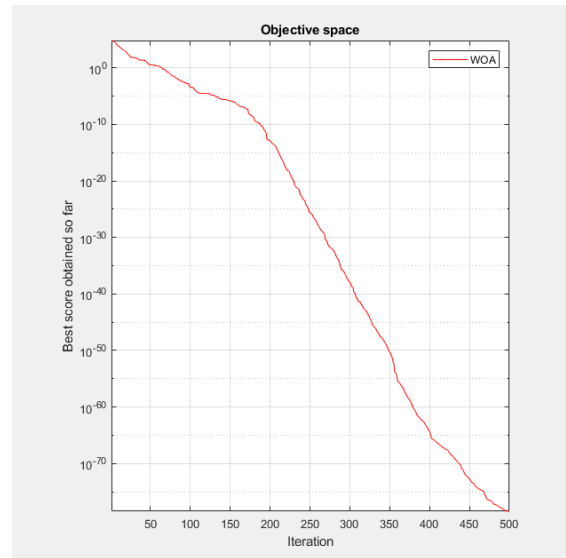

Figure 11. Iterative Objective Space of Whale Optimization Algorithm

In multi objective algorithm like Whale optimization algorithm, the fitness function and objective functions has been created before the algorithm runs. Fitness function tends to fit the system in order to improve the cost and objective function or cost function tends to minimize by increasing the fitness value in fitness function. In figure 22, as the iterations increases the fitness value increases, while the cost decreases or minimized.

### 4.7. Comparative Analysis

In the given table Author will compare Author study with some state of art researches, done previously:

References	Techniques	Total Hops	Iterations	Computational Time
Our Proposed	H-LEACH	102	3230	1000
Our Proposed	Optimized WOA	100	4305	1000
[15]	Particle Swarm Optimization	200	5000	2000
[12]	Learning-Based IoT Data Aggregation	320	5400	1200
[1]	Representation of Heterogeneous Data in Cloud-Edge Computing	420	6499	3300
[4]	Fast Multi-Objective Optimization	234	4564	3000
[31]	Coyote	239	7699	4000

[23]	Optimization Algorithm Cross-Layer-Sensing Clustering Method Based on Intelligent Fog Computing	348	6777	4400
[10]	Spatio-Temporal Correlation	300	9600	4300
[3]	Improving Classification of SVM	330	5588	4400
[32]	Hybrid Improved MVO and FNN	200	7999	5000
[7]	Edge Computing Model for Real-Time Self-Organizing Push	200	7789	5400
[11]	Novel Two-Fold Data Aggregation	300	7879	5400

We have used Whale Optimization Algorithm for the increase of network Lifetime. It will be improved when WOA will be applied on Hetero-LEACH, nodes will be deployed on the shorter path to sense the data and transmit it to the cluster, if the cluster will be on distant location the power will be lost, so the network life-time will be reduced. So WOA has increased the life time of network.

Computational complexity has been reduced by WOA, due to which delay has also been reduced.

Deceptive energy has increased, when the nodes will be at distant position then due to transmission, the nodes will lose energy, but in this case all of the nodes has gained the specific energy which will be beneficial for enhancing the network life.

Transmission on correct time, throughout, number of alive nodes, number of dead nodes factor have a huge impact on QOS.

## 5. Conclusion

WSN have many applications in different fields like medical, military, health and agriculture, etc., due to its data sensing and gathering abilities to Base station. The main issue in wireless sensor network is energy efficiency under consideration of QOS parameter like delay and security. Many of techniques have been proposed in literature but few work on energy efficient network with QOS. Due to lack of prior research in this area of study, this research will optimize the existing result in manner of giving efficient energy mechanisms and will also provide QOS as well as reduction of delay.

It is very important to calculate energy efficiency and data transmission rate in wireless sensor networks because it is widely used in every field of life, especially when Author are talking about medical, military and navigation system. After identifying main issues, this research will focus on energy efficiency and delay reduction. But other factors like security and average transmission time is not fully focused.

The exact problem domain has been finalized after reviewing the some articles and collected metadata for analysis and taxonomy of this research has been done. Some protocols like LEACH and techniques i.e. Fuzzy and Zigbee are under consideration. Some required tools like MATLAB and Network Simulator and required libraries has been installed but not finalized yet to use in this study.

The present study provides different method for evaluating Energy efficient nodes in WSN. Different dependent and independent variables find out which influences the QOS in WSN. This study main focus is to provide best energy efficiency with minimum delay in network. Some work can be enhancing in future in security and data average transmission time.

## References

- [1] I. D. Filip, A. V. Postoaca, R. D. Stochitioiu, D. F. Neatu, C. Negru, and F. Pop, "Data Capsule: Representation of Heterogeneous Data in Cloud-Edge Computing," *IEEE Access*, vol. 7, pp. 49558–49567, 2019, doi: 10.1109/ACCESS.2019.2910584.
- [2] A. Nespoli, E. Ogliari, S. Pretto, M. Gavazzeni, S. Vigani, and F. Paccanelli, "Electrical Load Forecast by Means of LSTM: The Impact of Data Quality," *Forecasting*, vol. 3, no. 1, pp. 91–101, 2021, doi: 10.3390/forecast3010006.
- [3] T. K. Dao, T. T. Nguyen, J. S. Pan, Y. Qiao, and Q. A. Lai, "Identification Failure Data for Cluster Heads Aggregation in WSN Based on Improving Classification of SVM," *IEEE Access*, vol. 8, pp. 61070–61084, 2020, doi: 10.1109/ACCESS.2020.2983219.
- [4] S. Koziel and A. Pietrenko-Dabrowska, "Fast multi-objective optimization of antenna structures by means of data-driven surrogates and dimensionality reduction," *IEEE Access*, vol. 8, pp. 183300–183311, 2020, doi: 10.1109/ACCESS.2020.3028911.
- [5] S. Bhushan, M. Kumar, P. Kumar, T. Stephan, A. Shankar, and P. Liu, "FAJIT: a fuzzy-based data aggregation technique for energy efficiency in wireless sensor network," *Complex Intell. Syst.*, vol. 7, no. 2, pp. 997–1007, 2021, doi: 10.1007/s40747-020-00258-w.
- [6] K. Singh, S. Rajora, D. K. Vishwakarma, G. Tripathi, S. Kumar, and G. S. Walia, "Crowd anomaly detection using Aggregation of Ensembles of fine-tuned ConvNets," *Neurocomputing*, vol. 371, pp. 188–198, 2020, doi: 10.1016/j.neucom.2019.08.059.
- [7] Y. Feng and S. Zhao, "Analysis of Edge Computing Model for Real-Time Self-Organizing Push of Data in Wireless LAN Environment," *IEEE Access*, vol. 7, pp. 178033–178046, 2019, doi: 10.1109/ACCESS.2019.2957025.
- [8] J. Ponocko and J. V. Milanovic, "Forecasting Demand Flexibility of Aggregated Residential Load Using Smart Meter Data," *IEEE Trans. Power Syst.*, vol. 33, no. 5, pp. 5446–5455, 2018, doi: 10.1109/TPWRS.2018.2799903.
- [9] J. Song, Q. Zhong, W. Wang, C. Su, Z. Tan, and Y. Liu, "FPDP: Flexible Privacy-Preserving Data Publishing Scheme

- for Smart Agriculture,” *IEEE Sens. J.*, vol. 21, no. 16, pp. 17430–17438, 2021, doi: 10.1109/JSEN.2020.3017695.
- [10] Y. Lu et al., “Data Collection Study Based on Spatio-Temporal Correlation in Event-Driven Sensor Networks,” *IEEE Access*, vol. 7, pp. 175857–175864, 2019, doi: 10.1109/ACCESS.2019.2957450.
- [11] P. Movva and P. T. Rao, “Novel Two-Fold Data Aggregation and MAC Scheduling to Support Energy Efficient Routing in Wireless Sensor Network,” *IEEE Access*, vol. 7, pp. 1260–1274, 2019, doi: 10.1109/ACCESS.2018.2888484.
- [12] M. Peng, S. Garg, X. Wang, A. Bradai, H. Lin, and M. S. Hossain, “Learning-Based IoT Data Aggregation for Disaster Scenarios,” *IEEE Access*, vol. 8, pp. 128490–128497, 2020, doi: 10.1109/ACCESS.2020.3008289.
- [13] V. J. Jariwala and D. C. Jinwala, *AdaptableSDA: secure data aggregation framework in wireless body area networks*. Elsevier Inc., 2020.
- [14] N. Yukinawa, S. Oba, K. Kato, and S. Ishii, “Optimal aggregation of binary classifiers for multiclass cancer diagnosis using gene expression profiles,” *IEEE/ACM Trans. Comput. Biol. Bioinforma.*, vol. 6, no. 2, pp. 333–343, 2009, doi: 10.1109/TCBB.2007.70239.
- [15] H. Zhang and Z. Li, “Energy-aware data gathering mechanism for mobile sink in wireless sensor networks using particle swarm optimization,” *IEEE Access*, vol. 8, pp. 177219–177227, 2020, doi: 10.1109/ACCESS.2020.3026113.
- [16] X. Hu, D. Dang, Y. Yao, and L. Ye, “Natural language aggregate query over RDF data,” *Inf. Sci. (Nij.)*, vol. 454–455, pp. 363–381, 2018, doi: 10.1016/j.ins.2018.04.042.
- [17] N. M. Durrani, N. Kafi, J. Shamsi, W. Haider, and A. M. Abbasi, “Secure multi-hop routing protocols in Wireless Sensor Networks: Requirements, challenges and solutions,” *8th Int. Conf. Digit. Inf. Manag. ICDIM 2013*, no. April 2015, pp. 41–48, 2013, doi: 10.1109/ICDIM.2013.6694001.
- [18] S. M. Murshed, A. M. Al-Hyari, J. Wendel, and L. Ansart, “Design and implementation of a 4D web application for analytical visualization of smart city applications,” *ISPRS Int. J. Geo-Information*, vol. 7, no. 7, 2018, doi: 10.3390/ijgi7070276.
- [19] U. M. Aivodji, S. Gams, and A. Martin, “IOTFLA: AA secured and privacy-preserving smart home architecture implementing federated learning,” *Proc. - 2019 IEEE Symp. Secur. Priv. Work. SPW 2019*, pp. 175–180, 2019, doi: 10.1109/SPW.2019.00041.
- [20] K. Kucuk, C. Bayilmis, A. F. Sonmez, and S. Kacar, “Crowd sensing aware disaster framework design with IoT technologies,” *J. Ambient Intell. Humaniz. Comput.*, vol. 11, no. 4, pp. 1709–1725, 2020, doi: 10.1007/s12652-019-01384-1.
- [21] Z. H. Wei and B. J. Hu, “A Fair Multi-Channel Assignment Algorithm with Practical Implementation in Distributed Cognitive Radio Networks,” *IEEE Access*, vol. 6, pp. 14255–14267, 2018, doi: 10.1109/ACCESS.2018.2808479.
- [22] L. Y. B et al., *Exploring graph mining approaches for dynamic heterogeneous networks*, vol. 1. Springer International Publishing, 2020.
- [23] Z. Sun et al., “An Energy-Efficient Cross-Layer-Sensing Clustering Method Based on Intelligent Fog Computing in WSNs,” *IEEE Access*, vol. 7, pp. 144165–144177, 2019, doi: 10.1109/ACCESS.2019.2944858.
- [24] S. Pervez and G. Alandjani, “Role of Internet of Things (IoT) in Higher Education,” *Proc. ADVED 2018- 4th Int. Conf. Adv. Educ. Soc. Sci.*, no. October, 2018.
- [25] K. Shafique, B. A. Khawaja, F. Sabir, S. Qazi, and M. Mustaqim, “Internet of things (IoT) for next-generation smart systems: A review of current challenges, future trends and prospects for emerging 5G-IoT Scenarios,” *IEEE Access*, vol. 8, pp. 23022–23040, 2020, doi: 10.1109/ACCESS.2020.2970118.
- [26] M. K. K. P. and M. S. M., “Energy Efficient Algorithms for Wireless Sensor Network,” *Ijarcece*, vol. 4, no. 1, pp. 342–346, 2015, doi: 10.17148/IJARCCCE.2015.4178.
- [27] M. Abdullah, A. Al-Thobaity, A. Bawazir, and N. Al-Harbe, “Energy Efficient Ensemble K-means and SVM for Wireless Sensor Network,” *Int. J. Comput. Technol.*, vol. 11, no. 9, pp. 3034–3042, 2013, doi: 10.24297/ijct.v11i9.3409.
- [28] Z. Ahmed, K. Mohamed, S. Zeeshan, and X. Q. Dong, “Artificial intelligence with multi-functional machine learning platform development for better healthcare and precision medicine,” *Database*, vol. 2020, 2020, doi: 10.1093/DATABASE/BAAA010.
- [29] G. Desolda, C. Ardito, M. F. Costabile, and M. Matera, “End-user composition of interactive applications through actionable UI components,” *J. Vis. Lang. Comput.*, vol. 42, pp. 46–59, 2017, doi: 10.1016/j.jvlc.2017.08.004.
- [30] M. R. Anawar, S. Wang, M. Azam Zia, A. K. Jadoon, U. Akram, and S. Raza, “Fog Computing: An Overview of Big IoT Data Analytics,” *Wirel. Commun. Mob. Comput.*, vol. 2018, 2018, doi: 10.1155/2018/7157192.
- [31] L. Li, L. Sun, Y. Xue, S. Li, X. Huang, and R. F. Mansour, “Fuzzy Multilevel Image Thresholding Based on Improved Coyote Optimization Algorithm,” *IEEE Access*, vol. 9, pp. 33595–33607, 2021, doi: 10.1109/ACCESS.2021.3060749.
- [32] T. K. Dao, J. Yu, T. T. Nguyen, and T. G. Ngo, “A Hybrid Improved MVO and FNN for Identifying Collected Data Failure in Cluster Heads in WSN,” *IEEE Access*, vol. 8, pp. 124311–124322, 2020, doi: 10.1109/ACCESS.2020.3005247.