

Engineering Analysis of the Closed-Type Wind Turbine Diffuser

K. B. Shakenov^{1,*} and M. T. Tolemis²

¹ Satbayev University, Power engineering department, 22 Satbayev str., 050013, Almaty, Republic of Kazakhstan

² Al-Farabi Kazakh National University, 71 al-Farabi Ave., 050040, Almaty, Republic of Kazakhstan

Abstract

In this paper considered the engineering analysis of a diffuser with a closed-type wind power plant by converting the kinetic energy of the oncoming wind into electrical energy. The study of the wind turbine diffuser was carried out in order to increase the energy efficiency of converting wind energy into electrical energy. The closed-type wind turbine design is converted into a finite element model for aerodynamic calculations. The model of a closed-type wind turbine is investigated by changing the angle of attack of the diffuser, with various options for its parameters in order to find the most optimal conditions for increasing the energy efficiency factor of the energy carrier, which will ensure high energy efficiency of converting wind energy into electrical energy. Based on the study results was recommended the diffuser with the optimal angle of attack by constructing a closed-type wind turbine.

Keywords: wind turbine, structural design, angle of attack, energy efficiency, kinetic energy, wind power, design and construction, electrical energy, optimal conditions, renewable resource.

Received on 06 June 2021, accepted on 12 September 2022, published on 16 February 2023

Copyright © 2023 K.B. Shakenov *et al.*, licensed to EAI. This is an open access article distributed under the terms of the [CC BY-NC-SA 4.0](#), which permits copying, redistributing, remixing, transformation, and building upon the material in any medium so long as the original work is properly cited.

doi: 10.4108/ew.v9i5.3044

*Corresponding author. Email: kalizhan-90@mail.ru

1. Introduction

To increase the energy efficiency of the converter, it is necessary to study and find the best design of the structure, which allows increasing the air mass flow rate, since even a slight increase in the air mass flow rate will have a great energy efficiency, because the kinetic energy depends on the speed in the third degree [1, 2].

In work [3], on the basis of engineering analysis, the results were obtained and appropriate recommendations were given for the effective use of the autonomous building roof by using closed-type wind turbines. In this work, we analyzed the diffuser of a closed-type wind turbine to increase its efficiency in the installation.

The study of the wind turbine confuser was carried out in the software-scale engineering analysis COMSOL Multiphysics, which carries out calculations using the finite element method. This method is widely used in

modeling the processes of diffusion, heat conduction, hydrodynamics, mechanics, and its scope is expanding with the capabilities of computing systems. Usually, for solutions of hydrodynamics, the Euler problem setting is used. The mesh overlaid on the computational domain remains stationary throughout the entire solution process. However, by using such an approach, difficulties arise in approximating convective terms [4].

These difficulties are removed by using the Lagrangian description of the medium. The essence of this approach is that the grid nodes move with the environment, which allows us to consider them as particles of the environment; in this case, the mesh itself is deformed or rearranged at each step of the solution. One of the methods using the Lagrangian description of the medium is PFEM - the finite element method with parts [5, 6, 7, 8].

The finite element method with particles is used to simulate fluid flows in a complex shape, fluid flows from

a free surface, splashing processes, as well as solving conjugate problems of hydroelasticity. To solve these problems, Lagrangian methods of various types are traditionally and efficiently used: in conjugate problems of hydroelasticity - the methods of vortex elements [9, 10], in modeling flows with a free surface - the method of smoothed particles SPH [11, 12]. The advantages and disadvantages of using early methods and particle methods as applied to solving various problems are discussed in detail in [13, 14].

To simulate a stream widely applied system of differential Navier-Stokes equations. The main problems in solving the Navier-Stokes equation are related to differential equations for the equations of motion of mass and motion. To solve these problems, methods of determining the pressure of the Poisson equation [15], equations for corrections [16], penalty functions [17], supplementing the continuity equation with a nonstationary term [18], and regularizing the matrix of coefficients with time derivatives [19, 20] are used. In addition, there is a problem of the existence and smoothness of the Navier-Stokes equation for the solution of which various methods are used [21-28].

The aim of the work is to find most efficient diffuser of the converter of wind energy, which will optimally convert the kinetic energy of this energy and increase the range of its operation by reducing its threshold.

There is must be solved: the design model of the wind turbine case in the software simulation for analysis must be sufficiently close to the full-scale model. For this, the model should be sufficiently small in the safety area to avoid errors in hydrodynamic calculations; the calculation area above the wind turbine model should be high enough to avoid narrowing the air flow.

2. Methods

A three-dimensional model of a closed-type WPP construction and a building roof is shown in Figure 1 and consists of the following elements:

- (i) the directive cone, located in the middle of the construction on one axis with the WPP housing, directs the air flow to the turbine blades area of the WPP;
- (ii) the housing of the WPP, consisting of a front cavity, made in the form of a truncated cone, and an expanding back cavity, which contribute to the acceleration of the air flow in the area of the turbine blades of the WPP;
- (iii) the ejector which is the outer part of the construction of WPPs, the inner side of which is constant at a small angle relative to the WPP housing, narrows and directs the air flow at the outlet to create a low pressure region behind the turbine by entrainment with a flow of exhaust air molecules. Thus, it additionally contributes to the acceleration of the air flow in the turbine blades area of the WPP.

This design contributes to an increase in the speed of the wind flow through the use of the confuser and diffuser. Orientation to wind is carried out due to the shank of the wind turbine located behind the body. A DC generator is used to convert the rotational mechanical energy into electrical energy and is located behind the guide cone at the border of the confuser and diffuser. The blades of the proposed low-power WPP are made of light composite materials, so the calculation of the load on them was not considered. The local WPP can be used in tourist recreation areas, farms, etc., where large capacities are not required, it is sufficient to install it on standard buildings without special strengthening of the building elements.

Figure 2 shows the cross-section of the closed-type wind turbine housing separately. Since the structural elements of the wind turbine are bodies of rotation, a cross-section of the model is used to simplify the calculation, computational operations and analysis of the most effective areas of the structure. This model is built in the "Geometry" interface of the software. Next, the material of the elements of the model under study is selected, in this case, air is selected as the current area and iron as the material of the wind turbine structure. Then the boundary conditions are set: inlet velocity, outlet pressure, symmetrical walls. This interface simulates the flow of a fluid with any velocity based on the solution of the Navier - Stokes equations in various formulations. This interface is designed to simulate low-velocity flows, creeping (Stokes) flows, laminar and turbulent fluid flows. To describe turbulent flows, the Reynolds-averaged Navier-Stokes equations (RANS) are used, supplemented by various turbulence models: standard and low Reynolds $k-\varepsilon$ models, $k-\omega$ and SST (Menter) models, and the Spalart-Allmaras model. The Reynolds averaging method for the Navier - Stokes equation consists in replacing randomly varying flow characteristics (velocity, pressure, density) with the sums of averaged and pulsation components. The Reynolds equations describe the time-averaged fluid flow, their feature (in comparison with the original Navier - Stokes equations) is that they have new unknown functions that characterize the apparent turbulent stresses.

To carry out the calculation, a standard $k-\varepsilon$ model was chosen to describe a turbulent flow, where the equations of motion are transformed to a form in which the influence of fluctuations in the average velocity (in the form of turbulent kinetic energy) and the process of reducing this fluctuation due to viscosity (dissipation) are added. This model solves two additional equations for the transport of kinetic energy of turbulence and transport of dissipation of turbulence. This model is most often used when solving real engineering problems.

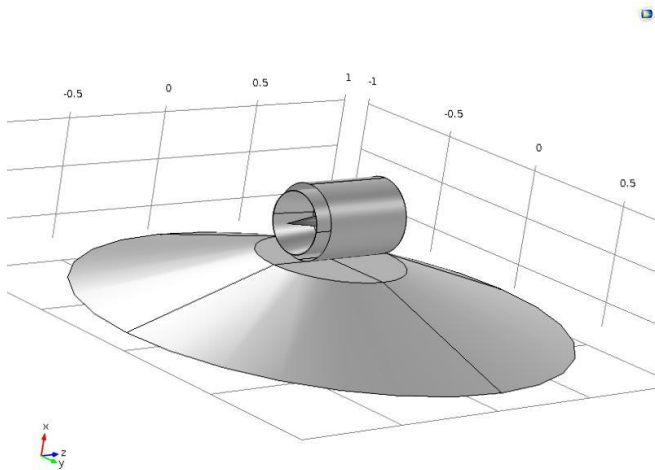

Figure 1. The three-dimensional model of the closed type WPP construction and roof of the building

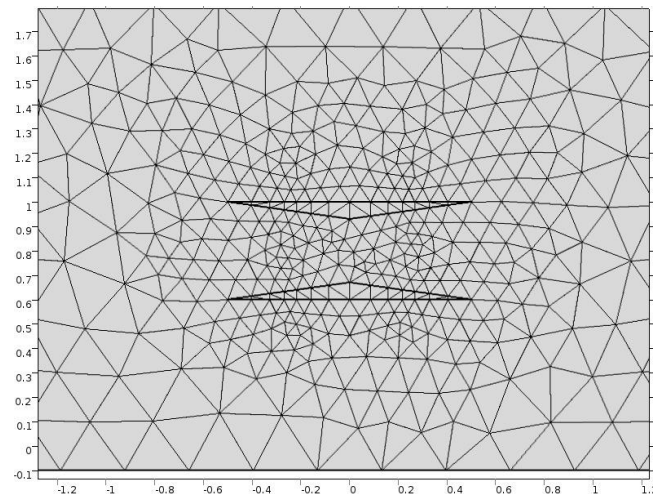

Figure 3. One of the options of the closed-type wind turbine housing computational grid

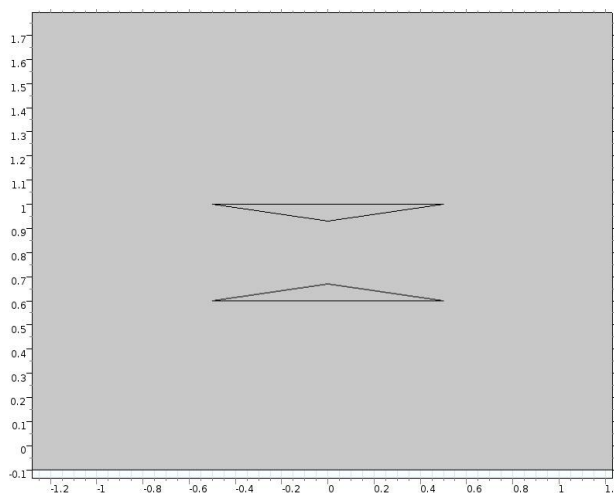

Figure 2. Cross-section of closed wind turbine housing

In the meshing interface, a method of dividing the model is selected from four types of calibration for each of its sections: “general physics”, “fluid dynamics”, “plasma”, “semiconductor”. Then a predefined grid size is set. For the area of the current environment of the model, the second type of calibration is selected, i.e. “Fluid dynamics”, and for the wind turbine design - the first type of calibration, i.e. “General physics”. The constructed mesh for one of the options of the closed-type wind turbine structure model is shown in Figure 3. It can be seen from the figure that the mesh near and along the edges of the structure is refined, which will take into account changes in parameters in these important zones for a sufficiently accurate description of flow processes.

3. Results and discussion

In work [29] concentrators for increasing wind speed are considered. Here, shaping affects the efficiency of wind generators. The proposed solutions for the new shaping of concentrators are not effective enough due to the lack of research on finding an effective design, and they also have different turns, where part of the kinetic energy of the wind is lost. In addition, work [30] compares several CFD RANS $k-\omega$ SST and LES models in modeling the wake of wind turbines. The structural uncertainty of RANS is quantified when predicting the wake of wind turbines without considering the influence of various types of wind turbine design in order to identify the most efficient power plant. Therefore, in order to identify the most efficient design of the power plant, it is necessary to carry out calculations under various conditions for each element of the installation.

The calculations were carried out by changing the length of the wind turbine body to obtain different angles of attack of the diffuser of the installation. The results of the calculations can be obtained in the form of various diagrams and graphs according to the necessary parameters for analyzing the results obtained. Figure 4 shows a diagram of the air flow velocity contours according to the design of a closed-type wind turbine. It can be seen that in the zone of the turbine, where the flow is narrowed by the casing and the wind turbine guide cone, the flow rate reaches its maximum value, beyond this zone the flow rate begins to decrease. A slight decrease in the air flow rate is observed along the outer edges of the wind turbine housing.

And the diagram of the pressure contours for these conditions is shown in Figure 5. It can be seen from this figure that the low pressure zone is located behind the

wind turbine, especially in the area of the wind turbine blades, where the maximum air flow rate is reached.

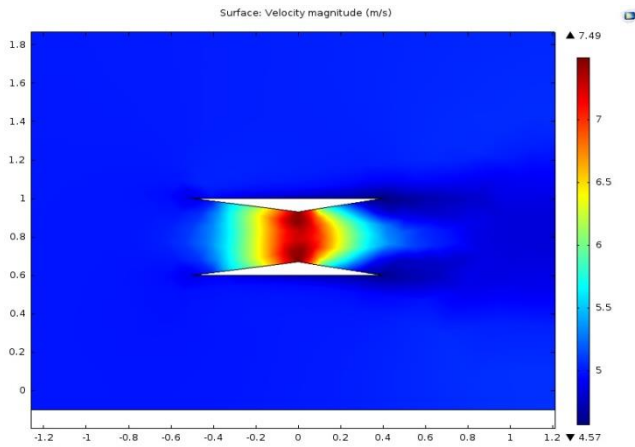

Figure 4. Closed-type wind turbine along the casing air flow velocities contours diagram

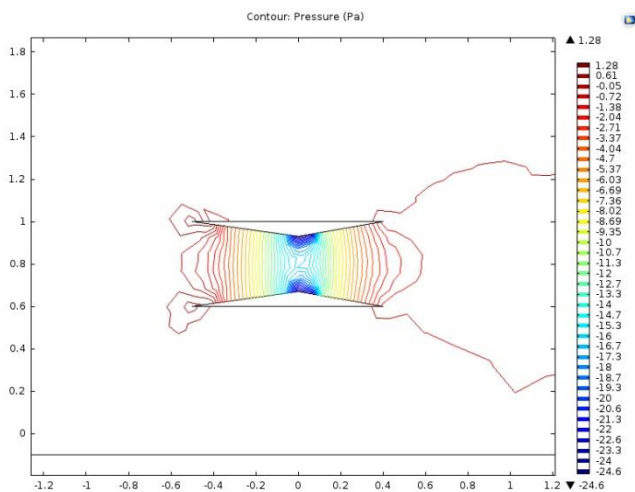

Figure 5. Pressure loops diagram of the air flow along the casing of the closed-type wind turbine

To obtain data on the speed in the area where the turbine is located (the vertically located red line in Figure 6), a graph of the dependence of the air flow rate on the length of this zone is plotted, which is shown in Figure 7. The drop in the air flow rate in the middle of the graph shows the shaded area of the guide cone of a closed-type wind turbine, where the generator and the turbine housing are located, as well as the increase in speed on the sides - the area of the turbine blades, where the maximum air flow rate in the structure is reached.

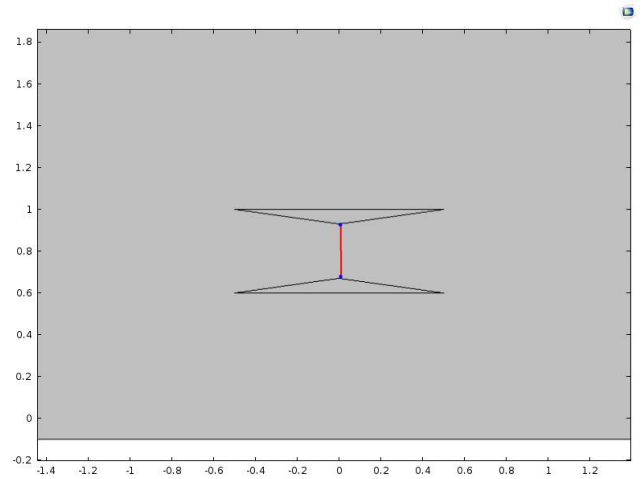

Figure 6. Air flow rate plotting area

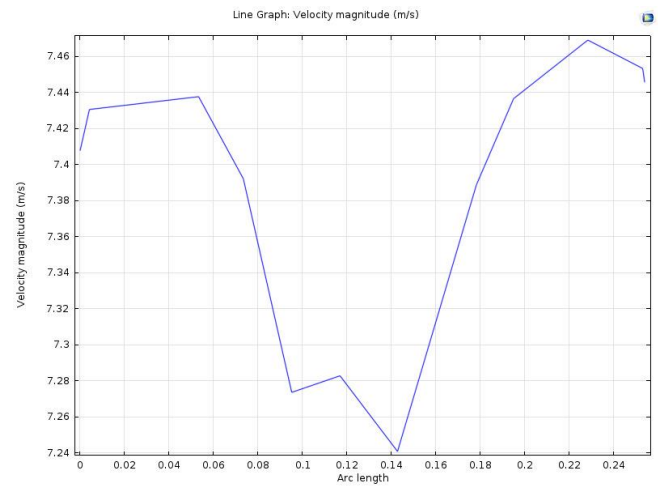

Figure 7. Air flow velocity graph at the location of closed-type wind turbine blades

The results of the calculations performed for various options at an initial wind speed from 5 m/s to 40 m/s are shown in Table 1

Table 1. Results of wind speed in the turbine area

ϑ_i , m/s	α , °	ϑ_{max} , m/s
5	7.97	7.33
	8.84	7.57
	9.93	7.49
	11.31	7.4
	13.13	7.46
	15.64	7.2
	19.29	7.24
	25.02	7.14
	34.99	6.99
10	7.97	14.8
	8.84	15.3
	9.93	15.1
	11.31	14.9
	13.13	15
	15.64	14.4
	19.29	14.5
	25.02	14.3
	34.99	14
15	7.97	22.2
	8.84	23
	9.93	22.7
	11.31	22.4
	13.13	22.5
	15.64	21.7
	19.29	21.8
	25.02	21.5
	34.99	21
20	7.97	29.7
	8.84	30.8
	9.93	30.4
	11.31	29.9
	13.13	30.1
	15.64	28.9
	19.29	29.1
	25.02	28.7
	34.99	28.1
25	7.97	37.2
	8.84	38.6
	9.93	38.1
	11.31	37.5
	13.13	37.7
	15.64	36.2
	19.29	36.4
	25.02	35.9
	34.99	35.1
30	7.97	44.8
	8.84	46.4
	9.93	45.9
	11.31	45.1
	13.13	45.3
	15.64	43.5
	19.29	43.7
	25.02	43.1
	34.99	42.2
35	7.97	52.4
	8.84	54.3
	9.93	53.7
	11.31	52.8

	13.13	53
	15.64	50.8
	19.29	51.1
	25.02	50.4
	34.99	49.2
40	7.97	60
	8.84	62.3
	9.93	61.5
	11.31	60.5
	13.13	60.7
	15.64	58.2
	19.29	58.5
	25.02	57.7
	34.99	56.3

Table 1 shows that the maximum acceleration of the air flow through the structure in the area of the turbine is achieved at a diffuser angle of attack of 8.84° . Therefore, when designing and building closed-type wind turbines, it is recommended to take the angle of attack of the diffuser in the region of 9° .

Conclusions

1. The shape of the wind turbine structure element has been developed to effectively increase the speed of the incoming air flow, such as a diffuser in the installation body.
2. The analysis of the change in the parameters of the wind turbine diffuser, in the absence of some elements, and at different angles of attack.
3. Based on the results of the analysis, an effective version of the design of the wind turbine was identified, where the greatest acceleration of the incoming air flow is achieved, and it was recommended to take the angle of attack of the diffuser in the region of 9° .

References

- [1] Bekbayev A.B., Shakenov K.B. (2018) Kompleksnoye ispolzovaniye vozobnovlyayemykh istochnikov energii i poputnykh gazov na nefteperekachivayushchikh nasosnykh agregatakh. [Integrated use of renewable energy sources and associated gases at oil pumping units] Materialy IX Mezhdunarodnoy nauchno-prakticheskoy konferentsii «Noveyshiye tekhnologii osvoyeniya mestorozhdeniy uglevodorodnogo syrta i obespecheniye bezopasnosti ekosistem Kaspiskogo shelfa» [Materials of the IX International Scientific and Practical Conference "The latest technologies for the development of hydrocarbon deposits and ensuring the safety of ecosystems of the Caspian shelf"], AGTU – Astrakhan: Izd-vo AGTU. Pp. 277-279. (in russian)
- [2] Bekbayev A.B., Shakenov K.B., Yerkinov G.Ye., Sagymbayev Zh.A. (2019) Ispolzovaniye energosberegayushchikh tekhnologiy dlya otdelnykh potrebitey rudnikov. [Use of energy-saving technologies for individual consumers of mines.] Trudy Mezhdunarodnykh Satpayevskikh chteniy «Innovatsionnyye tekhnologii – klyuch k uspeshnomu resheniyu fundamentalnykh i prikladnykh zadach v

- rudnom i neftegazovom sektorakh ekonomiki RK». [Proceedings of the International Satpayev Readings "Innovative technologies are the key to successfully solving fundamental and applied problems in the ore and oil and gas sectors of the economy of the Republic of Kazakhstan"] – Almaty: KazNITU. Vol. II, Pp. 1042-1045. (in russian)
- [3] Titkov V.V., Bekbayev A.B., Shakenov K.B. (2018) Analysis of the roof of an autonomous house for efficient use of wind energy. EAI Endorsed Transactions on Energy Web and Information Technologies. Vol. 6, Iss. 21. DOI: 10.4108/eai.12-9-2018.155859.
- [4] Davydova Ye. V., Korchagova V. N., Marchevskiy I. K. (2015) Ispolzovaniye metoda konechnykh elementovs chastitsami dlya resheniya zadach gidrodinamiki. [Use of the finite element method with particles to solve hydrodynamic problems.] Nauka i Obrazovaniye [Science and education.]. MGTU named after N.E. Bauman. No. 6. Pp. 329-345. (in russian)
- [5] Idelsohn S.R., Onate E., Del Pin F. (2003) A Lagrangian meshless finite element method applied to fluid-structure interaction problems. Computer and Structures. Vol. 81, No. 8-11. Pp. 655-671. DOI: 10.1016/S0045-7949(02)00477-7.
- [6] Cremonesi, M., Franci, A., Idelsohn, S., Oñate, E. (2020) A State of the Art Review of the Particle Finite Element Method (PFEM). Archives of Computational Methods in Engineering. 27(5). Pp.1709–1735. DOI: 10.1007/s11831-020-09468-4.
- [7] Idelsohn S.R., Onate E., Del Pin F. (2004) The particle finite element method: a powerful tool to solve incompressible flows with free-surfaces and breaking waves. International Journal for Numerical Methods in Engineering. Vol. 61, no. 7. Pp. 964-989. DOI: 10.1002/nme.1096.
- [8] Gimenez, J.M., Aguerre, H.J., Idelsohn, S.R., Nigro, N.M. (2019) A second-order in time and space particle-based method to solve flow problems on arbitrary meshes. Journal of Computational Physics. 380. Pp. 295–310. DOI: 10.1016/j.jcp.2018.11.034.
- [9] Chirag J. Parekh, Arnab Roy, Atal Bihari Harichandan. (2018) Numerical simulation of incompressible gusty flow past a circular cylinder. Alexandria Engineering Journal. Vol. 57, Issue 4. Pp. 3321-3332. DOI: 10.1016/j.aej.2017.12.008.
- [10] Kuzmina K.S., Marchevskiy I.K. (2016) High-Order Numerical Scheme for Vortex Layer Intensity Computation in Two-Dimensional Aerohydrodynamics Problems Solved by Vortex Element Method. Herald of the Bauman Moscow State Technical University Series Natural Sciences. No. 6. Pp. 93-109. DOI: 10.18698/1812-3368-2016-6-93-109.
- [11] Farrukh Mazhar, Ali Javed, Jing Tang Xing, Aamer Shahzad, Mohtashim Mansoor, Adnan Maqsood, Syed Irtiza Ali Shah, Kamran Asim. (2021) On the meshfree particle methods for fluid-structure interaction problems. Engineering Analysis with Boundary Elements. Vol. 124. P. 14-40. DOI: 10.1016/j.enganabound.2020.11.005.
- [12] Guibin Zhang, Jianyun Chen, Youting Qi, Jing Li, Qiang Xu. (2021) Numerical simulation of landslide generated impulse waves using a δ -LES-SPH model. Advances in Water Resources. Vol. 151, 103890. DOI: 10.1016/j.advwatres.2021.103890.
- [13] Idelsohn S.R., Onate E. (2006) To mesh or not to mesh. That is the question... Computer Methods in Applied Mechanics and Engineering. Vol. 195, iss. 37-40. Pp. 4681-4696. DOI: 10.1016/j.cma.2005.11.006.
- [14] Bravo, R., Ortiz, P., Idelsohn, S. et al. (2020) Sediment transport problems by the particle finite element method (PFEM). Comp. Part. Mech. 7. Pp. 139–149. DOI: 10.1007/s40571-019-00255-y.
- [15] Ma, Q.W., Zhou, Y. & Yan, S. (2016) A review on approaches to solving Poisson's equation in projection-based meshless methods for modelling strongly nonlinear water waves. J. Ocean Eng. Mar. Energy. 2. Pp. 279–299. DOI: 10.1007/s40722-016-0063-5.
- [16] Kaya U, Becker R, Braack M. (2021) Local pressure-correction for the Navier-Stokes equations. International Journal for Numerical Methods in Fluids. Vol. 93, Issue 4. Pp. 1199–1212. DOI: 10.1002/fld.4925.
- [17] Temam R. Uravneniye Navye-Stoksa. (1981) Teoriya i chislennyy analiz [Navier-Stokes equation. Theory and numerical analysis]. – M.: Mir. 408 p. (in russian)
- [18] Chorin A.J. (1997) A numerical method for solving incompressible viscous flow problems. Journal of Computational Physics. Vol. 135, iss. 2. Pp. 118-125. DOI: 10.1006/jcph.1997.5716.
- [19] Briley W.R., McDonald H. (1977) Solution of the multidimensional Navier-Stokes equations by a generalized implicit method. Journal of Computational Physics. 24(4). Pp. 372-397. DOI: 10.1016/0021-9991(77)90029-8.
- [20] Briley W.R., McDonald H., Shamroth S.J. (1983) A low Mach number Euler formulation and application to time-iterative LBI schemes. AIAA Journal. Vol. 21, No. 10. Pp.1464-1469. DOI: 10.2514/3.8291.
- [21] Asset A. Durmagambetov, Leyla S. Fazilova. (2015) Navier-Stokes Equations—Millennium Prize Problems. Natural Science. Vol.7, No. 2. Pp.88-99. DOI: 10.4236/ns.2015.72010.
- [22] Hyeong-Ohk Bae. (2018) Regularity of the 3D Navier–Stokes equations with viewpoint of 2D flow. Journal of Differential Equations 264(7). Pp. 4889-4900. DOI: 10.1016/j.jde.2017.12.026.
- [23] Hui Chen, Daoyuan Fang, Ting Zhang. (2017) Regularity of 3D axisymmetric Navier-Stokes equations. Discrete & Continuous Dynamical Systems. 37(4). Pp. 1923-1939. DOI: http://dx.doi.org/10.3934/dcds.2017081.
- [24] Chenyin Qian. (2016) A remark on the global regularity for the 3D Navier–Stokes equations. Applied Mathematics Letters. 57. Pp. 126-131. DOI: 10.1016/j.aml.2016.01.016.
- [25] J. Gibbon and Nairita Pal and A. Gupta and R. Pandit. (2016) Regularity criterion for solutions of the three-dimensional Cahn-Hilliard-Navier-Stokes equations and associated computations. Physical review. E. 94(6), 063103. DOI:10.1103/PhysRevE.94.063103.
- [26] D. Buaria and A. Pumir and E. Bodenschatz. (2020) Self-attenuation of extreme events in Navier–Stokes turbulence. Nature Communications. 11, 5852. DOI: 10.1038/s41467-020-19530-1.
- [27] Aristov, S.N., Prosviryakov, E.Y. (2016) Nonuniform convective Couette flow. Fluid Dyn. 51. Pp. 581–587. DOI: 10.1134/S001546281605001X
- [28] Aristov, S.N., Prosviryakov, E.Y. (2016) A new class of exact solutions for three-dimensional thermal diffusion equations. Theor. Found. Chem. Eng. 50. Pp. 286–293. DOI: 10.1134/S0040579516030027.
- [29] Bubenchikov A. A., Gorlinskiy N. A., Shcherbinov V. V. (2016) Kontsentratory potokov dlya vetroenergeticheskikh ustanovok [Concentrators for wind turbines]. Molodoy uchenyy [Young scientist]. No. 28.2 (132.2). Pp. 10-14.

[Online] URL: <https://moluch.ru/archive/132/36987/>
(reference date: 18.12.2020). (in russian)

- [30] Simon D. Hornshøj-Møller, Peter D. Nielsen, Pourya Forooghi, Mahdi Abkar. (2021) Quantifying structural uncertainties in Reynolds-averaged Navier–Stokes simulations of wind turbine wakes. *Renewable Energy*. 164. Pp. 1550-1558. DOI: 10.1016/j.renene.2020.10.148.