

Secure Smart and Remote Multipurpose Attendance Monitoring System

Azeem Khan¹, NZ Jhanjhi^{2,*}, Mamoon Humayun³

¹American Degree Program ADP, ² School of Computer Science and Engineering SCE, Lakeside Campus, Taylors University, Malaysia.

³College of Computer and Information Science, Jouf University, Al-Jouf, Saudi Arabia.

Abstract

Attendance monitoring system is an essential element in all organizations and is considered as an integral part of efficient organizational information systems. Most of the time it so happens that if any stakeholder wants to meet concerned in charge employees they need to take an appointment and then consult them. In situations where meeting becomes inevitable there is no system available to trace them with in the vicinity of the organization. The current research has been undertaken to address this issue, which is to know whereabouts of in charge employees during organizational timings. The proposed system works on RFID technology where in, as the concerned employees enters in the organization vicinity, his RFID will be validated with a check from the organizational database, if he/she is indeed an employee of the respective organization he/she will be allowed to enter into workspace and his attendance will be updated in the respective organizational database. Their status will be displayed on the screens available outside the workspace; apart from it the details will also be updated on cloud and the stakeholders willing to meet their respective personnel can easily see from the respective web-portal and can make an appointment based on their availability.

Keywords: Authentication, Smart Attendance Monitoring System, RFID, Secure

Received on 27 November 2019, accepted on 14 May 2020, published on 15 May 2020

Copyright © 2020 Azeem Khan *et al.*, licensed to EAI. This is an open access article distributed under the terms of the Creative Commons Attribution licence (<http://creativecommons.org/licenses/by/3.0/>), which permits unlimited use, distribution and reproduction in any medium so long as the original work is properly cited.

doi: 10.4108/eai.13-7-2018.164583

* Corresponding author. Email: Noorzaman.jhanjhi@taylors.edu.my

1. Introduction

Due to the advancement of technology and cut throat competition in the markets, it has become inevitable for almost all organizations to come up with solution strategies that could help them to be in par with the state of the art technology and exhibit productivity in all aspects of organizational progress. One of the key areas that is in need to be addressed by almost organizations is to come up with a strategy to keep in view the attendance of the employees in an organization. This aspect is one of the key indicators that contribute a lot to the organizational progress. There have

been conventional attendance monitoring systems to trace the attendance of the employees but due to their insecurity, inaccuracy, inefficiency and human error they have become obsolete, to address this space biometric devices and RFID technology has come into picture. when we compare the feasibility, cost and security of both these technologies; biometric devices are found to be expensive, insecure and time consuming whereas, RFID's as inexpensive, light weight, less time consuming, secure, easy to use and maintain.

The acronym RFID stands for Radio Frequency Identification; is a wireless identification technique [1]. It is basically a technology that is in use by several organizations to identify their personnel and physical objects like products etc., by the use of radio frequency. The identification process using RFID technology is done without any physical contact. RFID technology comprises of RFID tags, RFID Readers, Middleware and a Backend database as depicted in Fig 1.0. The tags are unique for their identification universally, and their operational frequency ranges from 125 KHz - 2.4 GHz. The records concerning to individual tags with their responsibilities are stored at Backend database. Middleware comprises software components like filters and hardware components such as cables, connectivity ports, etc., which are responsible for monitoring the network performance of the system[2]. RFID Tag is basically a microchip which consists of a unique identification number and it is stored in RFID memory. Apart from managing attendance of the personnel, RFID tags are also in use by various organizations such as educational institutions to store and manage records of books present in a library, to manage a large inventory system of stocks stored in ware houses, in livestock farming to constantly record and supervise the health of livestock for a timely response, etcetera [3]. Compared with biometric devices RFID technology is relatively lower in cost, light weight and involves less maintenance cost. This technique is much more advantageous, safe, secure and easy with lower overhead in contrast with the other conventional techniques used. Due to the aforesaid reasons, RFID tags are in use abundantly in the area of retail, logistics, pharmaceuticals, healthcare, education, sports, airline, animal farms, military, manufacturing, agriculture, security and transport. [4].

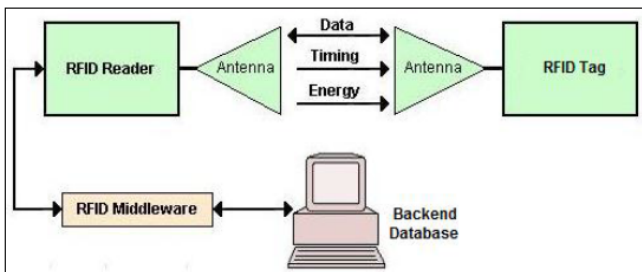

Fig. 1.0 Components of RFID System [2]

2.Literature Review

This section discusses the work done so far in attendance monitoring system. Saparkhojayev et al [5] presented a system based on RFID technology, wherein they have used RFID reader to read student ID , simultaneously they have also used web camera that takes student picture and this whole system was verified with their existing database; if the users were valid then their data of presence was updated in the database with a click on submit by the respective subject teacher. The whole system was implemented at Suleyman

Demirel University, Kazakhstan. They concluded that the proposed system was very efficient and less time consuming compared to conventional attendance monitoring systems which were time consuming, inefficient and error prone. They also stated that their system can be extended to other systems of university such as automating library, payment, parking and door controlling systems. Farooq et al[6] presented a system to control access of invalid users into the hostels of Punjab University premises. The proposed system integrated both RFID technology and biometrics to avoid illegal users trying to have access into the hostel premises. They designed a mechanism of their system in such a way that whenever any individual tries to access entrance into the university hostel as they tag their card installed at the entrance it detects a number which in turn captures the image and scans the data with the existing database, during this whole process if the user is found valid will be allowed to enter otherwise the system starts ringing alarm indicating that invalid users are trying to enter into campus thereby enabling the security personnel for further action. Though they have successfully demonstrated this system, they reported that there is still room for improvement in terms of response time which can be achieved by using dedicated processors instead of using dedicated nodes deployed to process images at real time. Sharma et al[7] proposed an algorithm to detect proxies in monitoring attendance using RFID technology, IoT and Cloud. The real time scenario which they addressed in this paper was, when students tries to enter the class they may use their own cards, but in some situations, morally bankrupt students can use their friends cards to gain attendance for them, to address this issue they have embedded video camera in the system which, apart from reading RFID tag by RFID Reader, is also able to capture image, one at the starting of class and the other before the end of the class and result of both is compared availing instant check with the existing database for the students presence, if it is found that a student by being absent physically but was trying to gain attendance via proxy, then system will automatically send warning email to that student, that he was trying to break the rule and if it continues next time, then severe action can be taken against him. For fast track analysis of attendance management system, Abas et al [8] proposed two different approaches, one that comprises of card reader and the other one using RFID. They designed, developed, implemented and tested two different approaches and concluded that the approach implemented with RFID Technology is faster, secure and efficient. Dwivedi et al[9] has reported RFID's growth, role of its discrete constituents and practicability of RFID technology on several real-world applications. They concluded their results by comparing with manual entries and barcode technology. They found that the proposed RFID technology surpasses other two technologies in terms of many aspects such as time, cost and performance, as depicted in Table 1.0 and Figure 1.1.

Table 1.0 [9]

Method	Total Number of Students			
	1	10	60	100
Manual Entry	10	100	600	1000
Barcode	2	20	120	200
RFID Technology	0.2	2	12	20

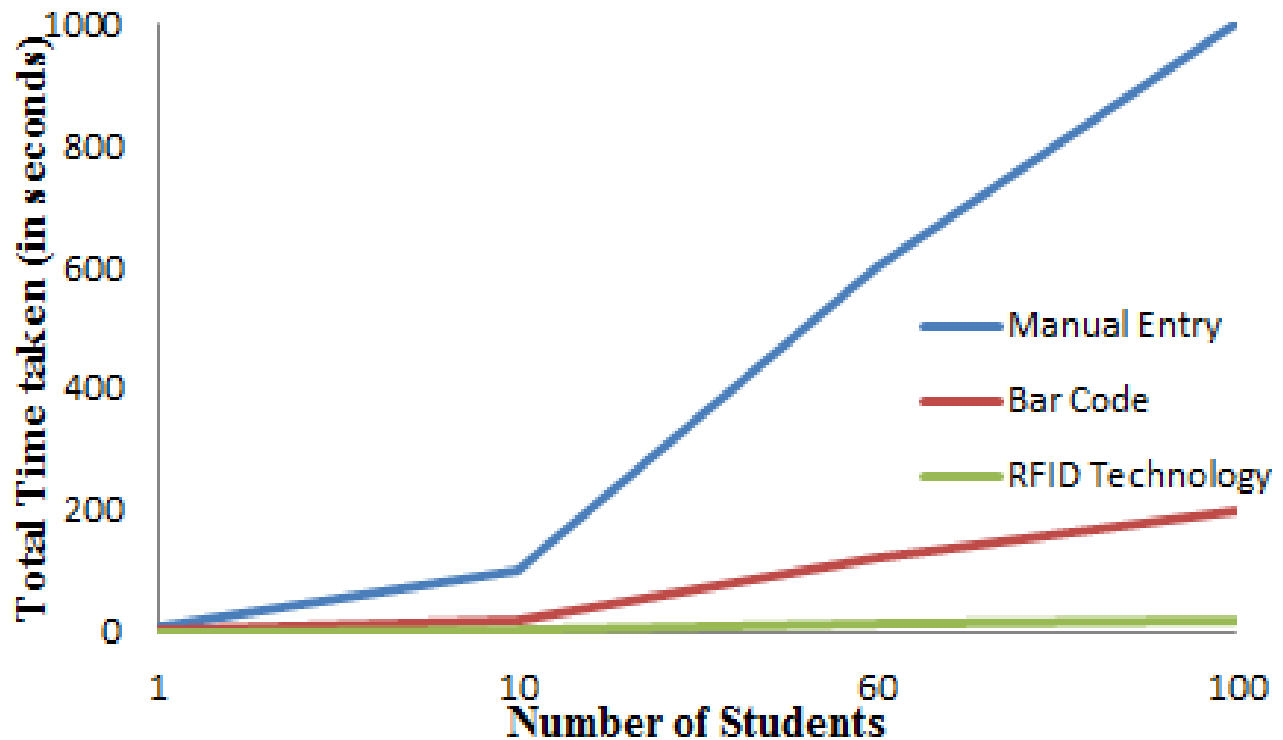

Fig 1.1 Time taken by various methods[9]

Oyetola et al[10] reported a study using biometric fingerprint mechanism, they captured around 500 students fingerprints, out of 500 they have used 200 for testing purpose and the rest for training purposes. They employed minutiae-based algorithm to extract biometric features. The extracted biometric features were encrypted using Advanced Encryption Standard Algorithm (AES). The proposed system was implemented using Java Programming Language. The performance of the proposed system was evaluated using False Reject Rate (FRR) and False Accept Rate (FAR) as performance metrics. Irawan et al [11] proposed a system for managing attendance for universities based on RFID and IoT.

They showed various types of tags available in the market as depicted in Fig 1.2. They also discussed various technologies system such as barcode, magnetic stripe and biometric devices that are in use to track the attendance of students and compared their results with them. They found that the proposed system incurs less cost, more secure and less time consuming. Overall, their results demonstrated that the proposed system outdoes existing technologies in many aspects and is found to be more efficient.



Fig 1.2 Types of RFID Tags[11]

Kamelia et al[12] proposed an online biometric fingerprint system to track workers working outside office, the whole system comprises of two modules that is fingerprint and GPS in Smartphones. Fingerprints enable workers to logon to the system from wherever they are and the GPS module tracks their whereabouts, the whole updated data is then sent to the concerned parties, to confirm and track their presence. The response time which they determined for fingerprint biometric system is about 1.39 seconds and workers location was traced through GPS with negligible error in their coordinates. Bhattacharya et al [13] proposed a system for monitoring students attendance in a university through face recognition. They concluded that their system is still in initial stage of development and can be upgraded further. Garg et al [14] reported a study comprising of attendance system based on biometric technologies, from a Human Resource Management's Perspective. Zatin & Rajneesh [15] proposed a system, by utilizing GSM cellular network, based on RFID technology. The proposed system monitors student's attendance remotely with a push-based SMS. Advantages of their proposed system includes student's attendance record to the parents on daily basis and employee's attendance

notification as they punch which reduces the overhead of compiling attendance at the end of the month. The new era technologies brought smart and efficient solutions to our lives to enhance the maximum comfort level. However, these emerging technologies have higher issues of security, as well in most of the smart and secure systems [16-19], which are highly required to address them accordingly. In [20-22] the researchers focused on IoT and blockchain security role and issues in smart environment, which can help to make them smarter. In [22] authors presented an RFID based approach attendance system using GPS for the wider area and its benefits, they elaborated the need of wireless and smart attendance system to control huge volume of employees remotely as well.

3. Proposed RFID Secure Smart and Remote Multipurpose Attendance Monitoring System

It is evident from the literature review that, RFID technology is in use by several researchers to develop and access control systems for students in universities and employees working

in an organization. The current research is aimed at providing solution for secure smart and remotely accessible Multipurpose Attendance Monitoring System

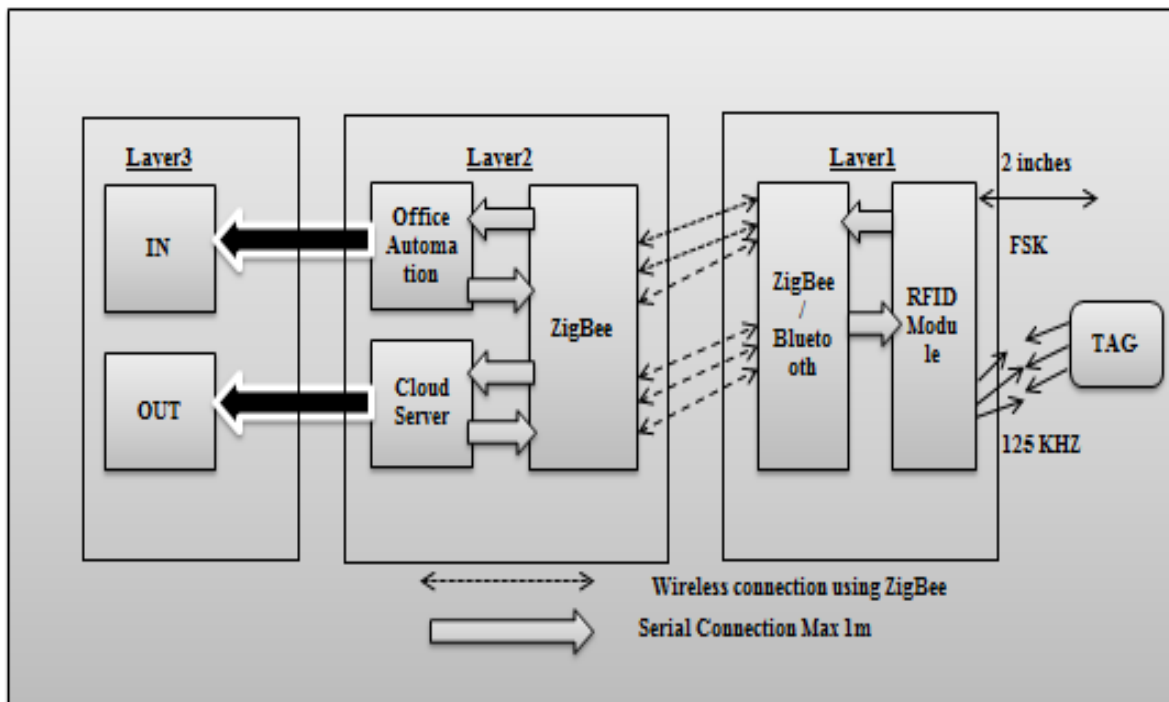

Fig 1.3. proposed system block diagram

As illustrated in Fig 1.3 our proposed system comprises of three layers, layer1 which consists of RFID reader, comprising RFID module enabled with ZigBee/Bluetooth. Layer2 is an application layer comprising of ZigBee, office automation and cloud server modules, and lastly layer3 which comprises of a display screen module that is responsible for displaying the status and timestamp of users. The whole system works as described in Fig 1.4: as the user tries to access entry into the system through RFID tag, the RFID reader module enabled with ZigBee and Bluetooth sends data to next layer where there the tag is scanned and sent to layer2 to check with the existing database records through cloud server. The user is validated with the existing

database; if the user is found to be invalid then their access will be denied and the entrance door will not open for them as shown in Fig 1.6., conversely if the user is valid then they are allowed to enter by enabling the door open as show in Fig 1.5 and their attendance will be updated in the database via cloud server, and their status will be sent to third layer which is basically a display screen wherein their name, status, location, timestamp and pictures will be displayed on the screen as well as on cloud server as depicted in Fig 1.7. Thus, enabling higher authorities and concerned persons to know the whereabouts of the personnel within the vicinity of the organization graphically as shown in Fig 1.8.

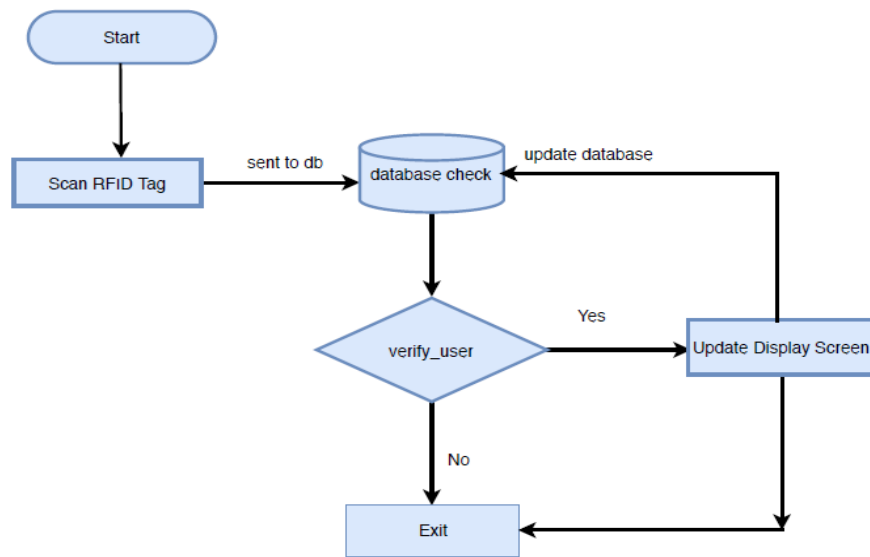

Fig 1.4. Flow chart of the proposed system

Algorithm: Secure Smart and Remote Multipurpose Attendance Monitoring System

Input: Scan RFID Tag

Operations performed:

- Verifying tag with database,
- Grant or deny access to workspace,
- Update attendance in database,
- Update Cloud database
- Update display screen

Begin

- Read Staff_RFID_tag
- If Staff_RFID_tag matches with existing database records
 - Grant access to workspace
 - Update attendance records in database
 - Update Cloud database
 - Update display screen:
With Name, Status, Location, Timestamp and Picture
- Else
 - Access denied to workspace

End

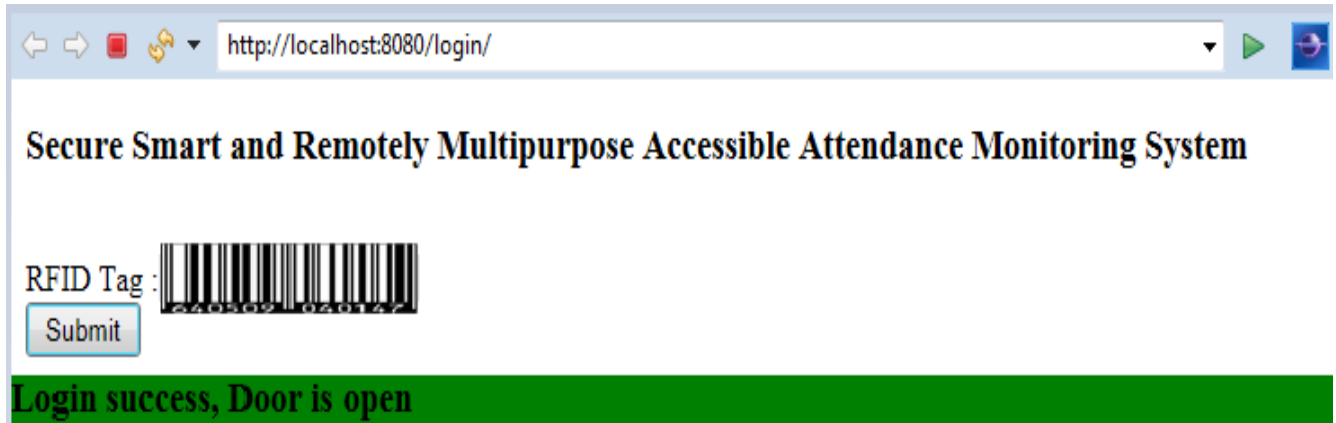

Fig 1.5 Successful Login Screen

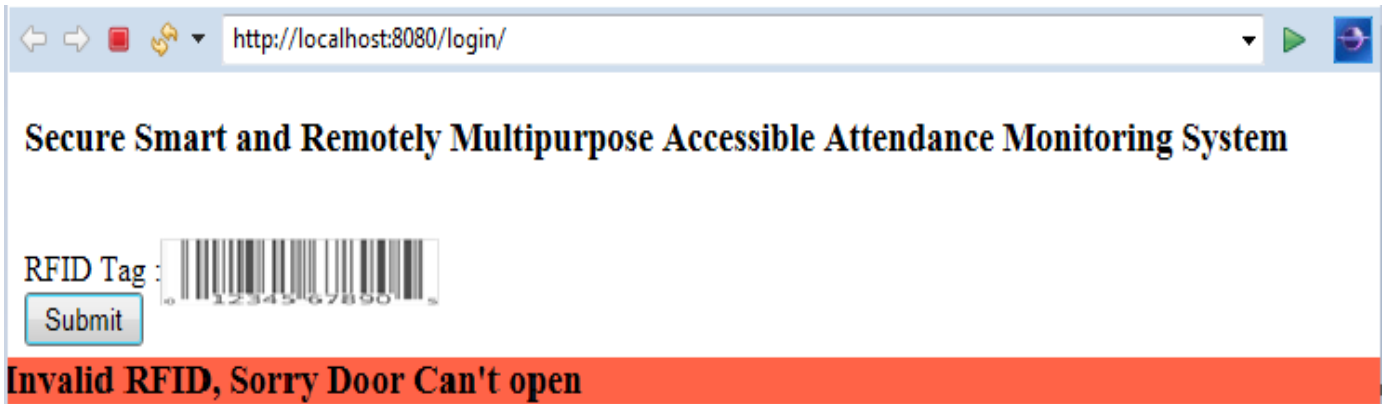

Fig 1.6 Unsuccessful Login Screen

Rfid	Name	Cabin_number	Came_at	Status	photo
1234100	Venkata Prabhakar	C9.01	2019-04-07 8:42:04	IN	
1234101	Alvin Ng Hui	C9.02	2019-04-07 8:45:06	IN	
1234102	Imaam Shaikh	C9.03	2019-04-07 8:49:04	IN	
1234103	Irfan Anjum	C9.04	2019-04-07 9:20:04	IN	
1234104	Syed Hasan	C9.05	2019-04-07 9:25:04	IN	
1234105	Noor ul Amin	C9.06	2019-04-07 9:32:04	IN	
1234106	Syed Umar	C9.07	2019-04-07 9:42:04	IN	
1234107	Yunus Khan	C9.08	2019-04-07 9:48:04	IN	
1234108	Noor Zaman	C9.09	2019-04-07 9:52:04	OUT	
1234109	Azeem Khan	C9.10	2019-04-07 9:55:04	OUT	

Fig 1.7 Employees Display Screen

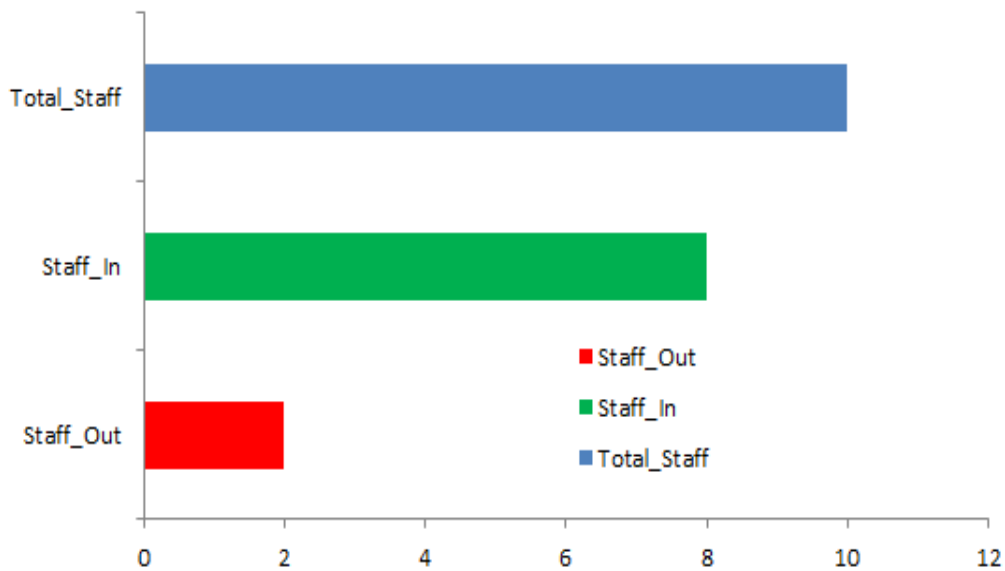

Fig 1.8 Users Graphical Report

4. Result and Discussion

Though various researchers have carried out their work to address intricacies involved in monitoring employee's attendance system in corporate world and students studying in universities. It is found from the literature review that there are still several issues which can be explored further. From the above literature review it is obvious that RFID technology has many advantages compared with conventional systems and other technologies such as barcode and biometric devices. When we compare RFID with biometric devices, RFID's are relatively lower in cost, secure, faster, easy to maintain and efficient conversely, biometric devices involve more maintenance cost apart from consuming more time as the user approaches these systems. For instance let us consider a scenario wherein a fingerprint module is installed in an organization then for each employee to touch and go is time consuming and if the employees of an organization are many especially if we consider an organization such as manufacturing sector wherein, the number of workers will be many, if these kind of organizations use biometric devices then the time taken to login itself will be massive and sometimes it may so happen that if the biometric device contains stains then the fingerprints will not be matched with the existing database making whole system a mess as no worker can log in. To avoid all these hassles and to make the organization function smoother and safer RFID is regarded as the best solution so far especially for scenarios wherein number of employees are many. A research carried out by [9] clearly shows how RFID technology surpasses other technologies such as barcode and convention systems where in the attendance is taken manually hence we benchmark this for our study and we consider the technology far over experimental basis. Though many systems have been developed to trace attendance of the students studying in an university or employees working in an organization, it has been found from the literature review that all systems that are developed and deployed addresses a specific issue leaving room for many other issues to be addressed. The current research has been undertaken to address a specific issue where in apart from validating the user with the existing database, the data is sent to the cloud and the whereabouts of the users interacting with the system can be traced by the authorities involved in managing that organization. To develop this system following technologies have been used viz., Java Servlets, Java Server Pages and MySQL apart from RFID Reader Module. The proposed system implemented is efficient and stable and it can be extended to many other organizations as well, apart from just monitoring attendance of the universities students alone. We choose RFID based on multiple reasons, including its ease of functionality, cheaper in cost, efficient in use etc. as stated in the literature review section generally and particularly in table 1.

5. Conclusion

Attendance monitoring system is an essential part in all organizations and is considered as an integral part of efficient organizational information systems. To address this issue many technologies have come into existence with their own limitations in terms of maintenance, cost, efficiency and time consumption. Among all these proposed and implemented technologies RFID has become popular due to many advantages pertaining to it, in terms of cost, efficiency, time consumption and scalability. Though many systems have been developed and implemented using RFID technology to manage and maintain attendance monitoring system there are still many issues that were not addressed in those systems, the current research has been undertaken to address one such issue wherein apart from valid users being granted access to enter into the workspace, their data is updated via cloud server and their whereabouts are displayed on the screen locally as well as online, thereby, enabling concerned authorities to trace their respective personnel working in their organization.

6. Future work

Apart from addressing the issue of universities attendance monitoring system alone, the proposed system can be extended to any organization wherein the whereabouts of an employee are in need to be traced by the higher authorities of an organization.

References

- [1] Z. Singhal and R. K. Gujral, "Anytime anywhere-remote monitoring of attendance system based on RFID using GSM network," *International Journal of Computer Applications*, vol. 39, pp. 37-41, 2012.
- [2] S. Nainan, R. Parekh, and T. Shah, "RFID technology based attendance management system," *arXiv preprint arXiv:1306.5381*, 2013.
- [3] G. D. P. Maramis and P. T. D. Rompas, "Radio Frequency Identification (RFID) Based Employee Attendance Management System," *IOP Conference Series: Materials Science and Engineering*, vol. 306, p. 012045, 2018.
- [4] R. Aqeel ur, A. Z. Abbasi, and Z. A. Shaikh, "Building a Smart University Using RFID Technology," pp. 641-644, 2008.
- [5] N. Saparkhojaye and S. Guvercin, "Attendance Control System based on RFID-technology," *International Journal of Computer Science Issues (IJCSI)*, vol. 9, p. 227, 2012.
- [6] U. Farooq, M. ul Hasan, M. Amar, A. Hanif, and M. Usman Asad, "RFID Based Security and Access Control System," *International Journal of Engineering and Technology*, pp. 309-314, 2014.
- [7] T. Sharma and S. Aarthy, "An automatic attendance monitoring system using RFID and IOT using Cloud," in 2016

- Online International Conference on Green Engineering and Technologies (IC-GET), 2016, pp. 1-4.
- [8] M. A. Abas and M. Dahlui, "Attendance management system (AMS): Comparison of two different approaches," in 2017 International Conference on Engineering Technology and Technopreneurship (ICE2T), 2017, pp. 1-7.
- [9] J. Dwivedi, A. Tyagi, A. Pushkar, D. K. Tiwari, R. Anand, S. Dubey, et al., "Rfid technology based attendance management system," International Journal of Engineering Science and Computing (IJESC), vol. 7, 2017.
- [10] O. A. A. Oyetola O.K. , Olaluwoye O.O, "A Secure Students' Attendance Monitoring System," vol. 2, ed, 2017, pp. Amity Journal of Engineering and Technology (AJET),.
- [11] J. D. Irawan, E. Adriantantri, and A. Farid, "Rfid and iot for attendance monitoring system," in MATEC Web of Conferences, 2018, p. 01020.
- [12] L. Kamelia, E. A. D. Hamidi, W. Darmalaksana, and A. Nugraha, "Real-Time Online Attendance System Based on Fingerprint and GPS in the Smartphone," in 2018 4th International Conference on Wireless and Telematics (ICWT), 2018, pp. 1-4.
- [13] S. Bhattacharya, G. S. Nainala, P. Das, and A. Routray, "Smart Attendance Monitoring System (SAMS): A Face Recognition Based Attendance System for Classroom Environment," pp. 358-360, 2018.
- [14] V. Garg, A. Singhal, and P. Tiwari, "A Study on Transformation in Technological Based Biometrics Attendance System: Human Resource Management Practice," in 2018 8th International Conference on Cloud Computing, Data Science & Engineering (Confluence), 2018, pp. 809-813.
- [15] G. R. K. Zatin S., "Anytime Anywhere- Remote Monitoring of Attendance System based on RFID using GSM Network," vol. 39.
- [16] ZA Almusaylim, N Zaman, A review on Smart home present state and challenges: linked to context awareness internet of things (IoT), in Journal Wireless Networks, 2018, pp. 1-12.
- [17] M. Almulhim and N. Zaman, proposing secure and lightweight authentication scheme for IoT based E-health applications, in 20th International Conference on Advanced Communication Technology (ICACT), Chuncheon-si Gangwon-do, Korea (South), 2018, pp. 481-487.
- [18] Maher Omar Alshammari, Abdulmohsen A. Almulhem and Noor Zaman, Internet of Things (IoT): Charity Automation, International Journal of Advanced Computer Science and Applications (IJACSA), 8(2), 2017. <http://dx.doi.org/10.14569/IJACSA.2017.080222>.
- [19] Almulhim, Maria, Nazurl Islam, and Noor Zaman. "A Lightweight and Secure Authentication Scheme for IoT Based E-Health Applications." International Journal Of Computer Science And Network Security 19, no. 1 (2019): 107-120.
- [20] Khan, A., Jhanjhi, N. Z., Humayun, M., & Ahmad, M. (2020). The Role of IoT in Digital Governance. In V. Ponnusamy, K. Rafique, & N. Zaman (Eds.), *Employing Recent Technologies for Improved Digital Governance* (pp. 128-150). Hershey, PA: IGI Global. doi:10.4018/978-1-7998-1851-9.ch007.
- [21] Alamri, M.; Jhanjhi, N.Z.; Humayun, M. Blockchain for Internet of Things (IoT) Research Issues Challenges & Future Directions: A Review. *Int. J. Comput. Sci. Netw. Secur.* 2019, 19, 244–258
- [22] Ponnusamy, V., Rafique, K., & Zaman, N. (2020). *Employing Recent Technologies for Improved Digital Governance* (pp. 1-383). Hershey, PA: IGI Global. doi:10.4018/978-1-7998-1851-9
- [23] Akbar Nagani, Payal Gour, Aqeeba Sheikh, Rakhi Kanoje, Ruby Afshan., "A Review of GPS Attendance System Using RFID in IoT." *International Journal Of Scientific Research in Science and Technology*, vol 4, issue 3, (2018): 490-493.